

Comercializado por: ASTRAL POOL S.A.U. NIF A-17583105. Avda. Francesc Macià, 38 Planta 16. 08208 Sabadell, Barcelona, Spain.
www.astralpool.com Fabricado por: NIF A-17092610

• Мы оставляем за собой право частично или полностью изменять характеристики наших изделий или содержание данного документа без предварительного уведомления.

- | | | | | | | |
|-------|-------|-------|-------|-------|-------|-------|
| 00258 | 00270 | 00271 | 00273 | 01466 | 01467 | 07880 |
| 27125 | 27814 | 27837 | 27838 | 27839 | | |



1

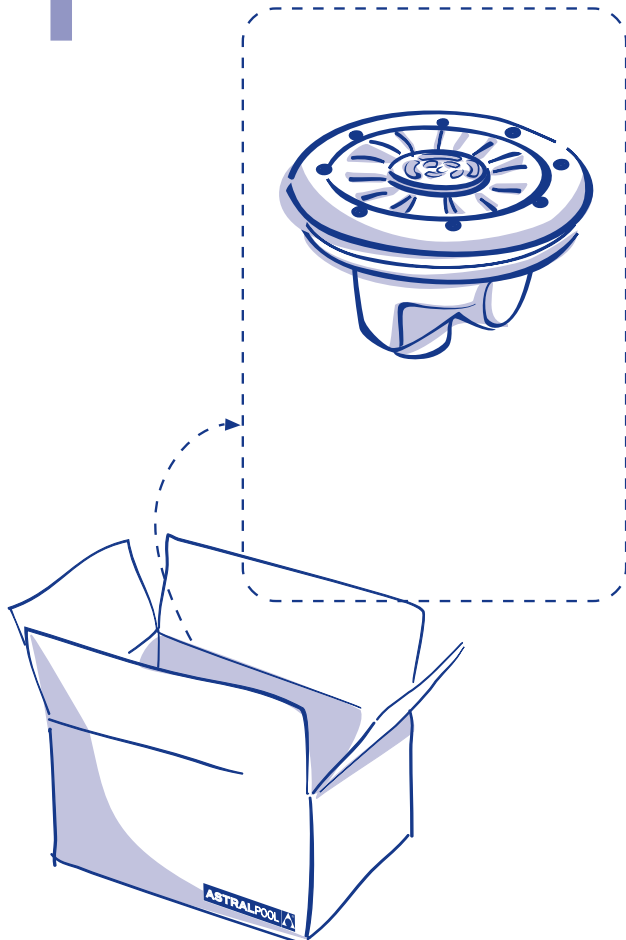

2

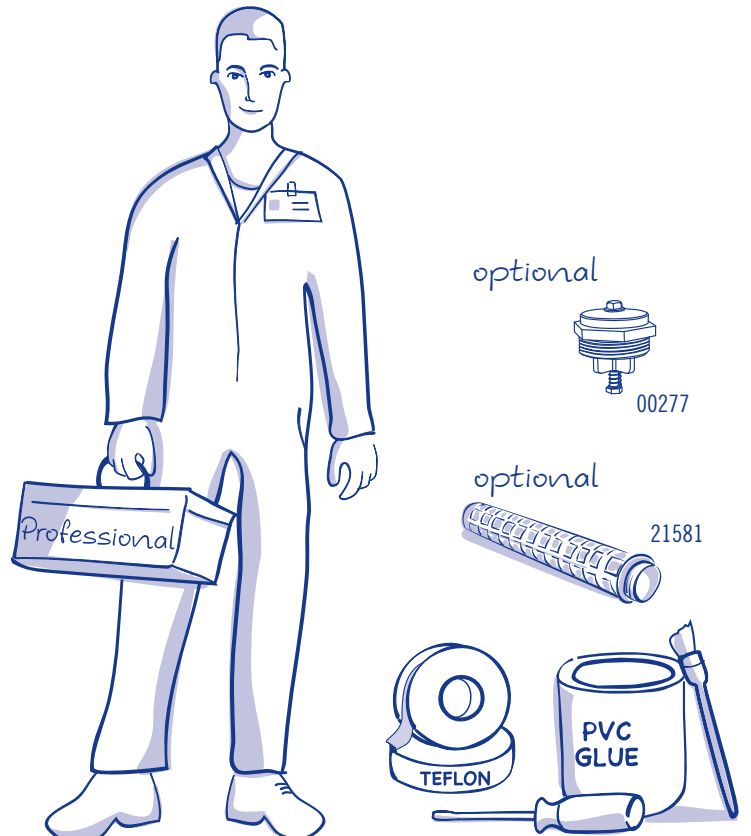

3

(a)



00258 00270 00271 00273 01466 01467
07880 27125 27837 27838 27839

$Q \leq 13 \text{ m}^3/\text{h}$

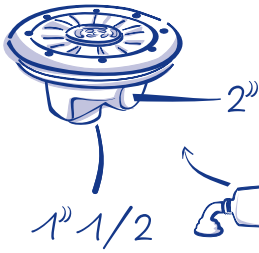

27814
 $Q \leq 11 \text{ m}^3/\text{h}$



(b)



EN 13541-1

$v \leq 0.5 \text{ m/s}$

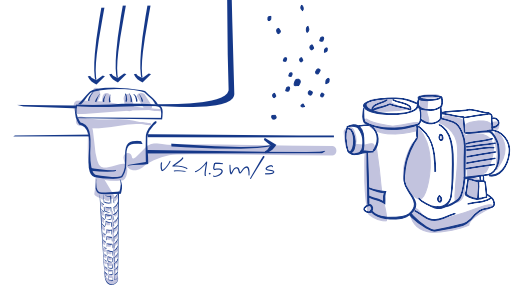

(c)



EN 13541-1

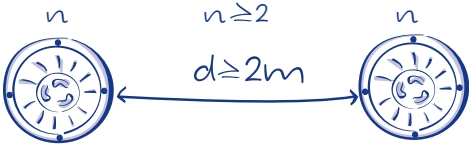

(d)



OK

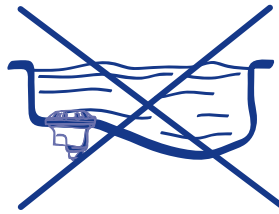

(e)



00258 00273

OK

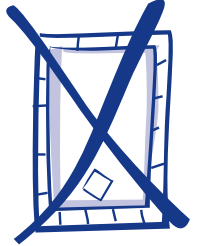
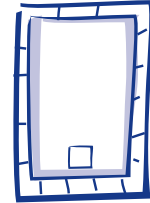

4

Concrete Pool

00258 01466 01467 27837 27839

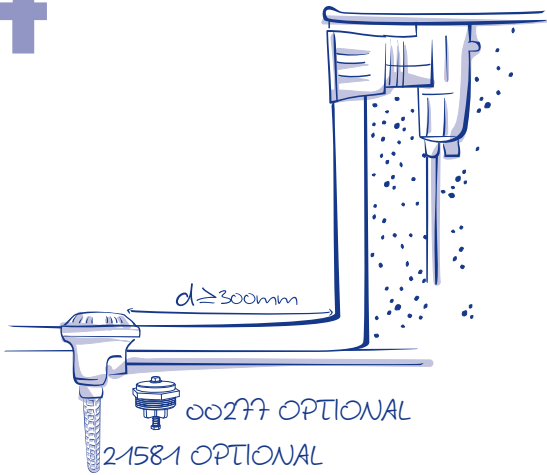

Polyester Pool

00270 00271 00273 07880 27125 27814 27838

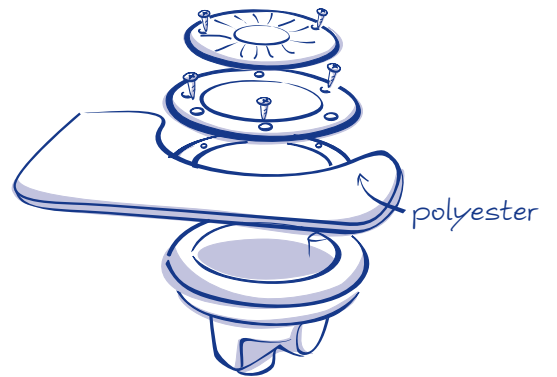

Concrete Pool with liner

00270 00271 00273 07880 27125 27814 27838

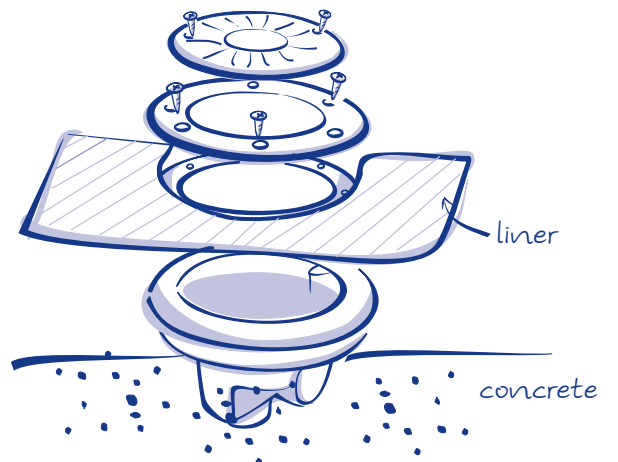

5

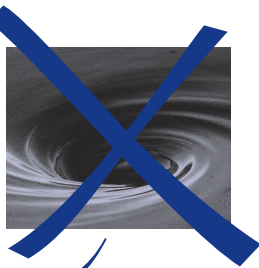

Antivortex

