

## ► SKIMMER 15L PISCINA PREF. / SKIMMER 15L PREF. POOL

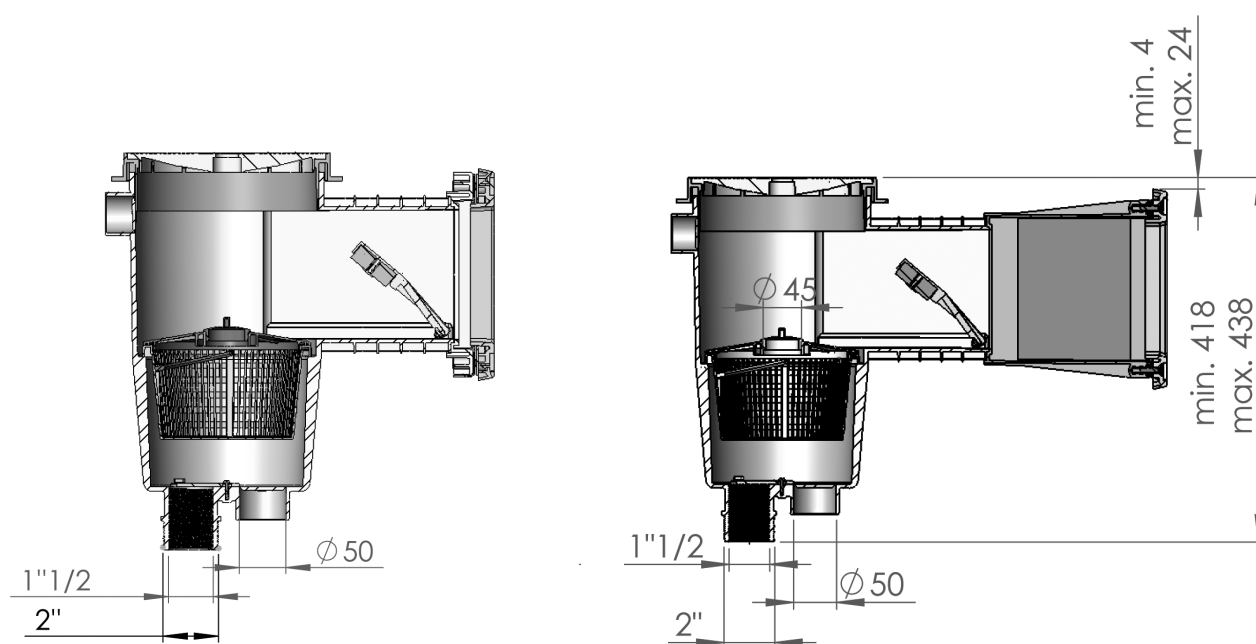







### DESCRIPCIÓN DEL PRODUCTO / PRODUCT DESCRIPTION

Todos los skimmers de la gama tienen tratamiento UV en las partes que no quedan enterradas. Fabricados en ABS blanco, con flotador de compuerta y clapeta para regulación de caudal. Conexión inferior de aspiración: rosca int. 1 1/2", ext. 2". Conexión simultánea al sumidero: Ø int. 50. Conexión superior de evacuación de agua sobrante Ø 40. Cesto recogehojas. Caudal recomendado 5 m<sup>3</sup>/h. Se recomienda instalar un skimmer por cada 25 m<sup>2</sup> de superficie de lámina de agua.

*All exposed skimmer parts are UV resistant. In white ABS with silent wier flap and flow regulation plug. 1 1/2" female - 2" male suction connections. Ø 50 mm solvent connection also provided. Overflow connection Ø 40 mm. Basket secured to base with bayonet fixing. Recommended flow 5 m<sup>3</sup>/h. We recommend installing one skimmer for every 25 m<sup>2</sup> of water surface area.*

## ► CARACTERÍSTICAS TÉCNICAS / TECHNICAL CHARACTERISTICS

CARACTERÍSTICAS CHARACTERISTICS	01461	01462	01463	01464	06469	06470*	06472
Tipo de boca Type of throat	■	■	■	■	■	■	■
Forma tapa Lid form	●	■	●	■	■	■	■
Conexiones inferiores Bottom connections	1 ½" - 2"	1 ½" - 2"	1 ½" - 2"	1 ½" - 2"	1 ½" - 2"	1 ½" - 2"	1 ½" - 2"
Caudal recomendado Recommended flow rate	5 m <sup>3</sup> /h	5 m <sup>3</sup> /h	5 m <sup>3</sup> /h	5 m <sup>3</sup> /h	5 m <sup>3</sup> /h	5 m <sup>3</sup> /h	5 m <sup>3</sup> /h
Superficie recomendada Recommended surface	cada 25 m <sup>2</sup> every 25 m <sup>2</sup>	cada 25 m <sup>2</sup> every 25 m <sup>2</sup>	cada 25 m <sup>2</sup> every 25 m <sup>2</sup>	cada 25 m <sup>2</sup> every 25 m <sup>2</sup>	cada 25 m <sup>2</sup> every 25 m <sup>2</sup>	cada 25 m <sup>2</sup> every 25 m <sup>2</sup>	cada 25 m <sup>2</sup> every 25 m <sup>2</sup>
Insertos Inserts	✓	✓	✓	✓	-	-	-
Color Colour							

\*06470 sin juntas / without joints

## ► LOGÍSTICA / LOGISTICS

### EMBALAJE Y PALETIZADO / PALLETIZED AND PACKAGING

Código - Code	01461 - 01462 - 06472			01463 - 01464 - 06469 - 06470		
	a	b	c	a	b	c
Medidas caja (mm) - Box sizes (mm)	432	317	434	587	452	436
Unidades / Caja - Units / Box	1			1		
Volumen / Caja (m <sup>3</sup> ) - Volume / Box (m <sup>3</sup> )	0,059			0,112		
Peso / Caja (Kg) - Weight / Box (Kg)	4			5,28		
Medidas palet (mm) - Pallet sizes (mm)	a	b	c	a	b	c
	1000	1200	2320	1000	1200	2300
Unidades / Palet - Units / Pallet	40			20		
Volumen / Palet (m <sup>3</sup> ) - Volume / Pallet (m <sup>3</sup> )	2,784			2,748		
Peso / Palet (Kg) - Weight / Pallet (Kg)	168,56			114,16		

#### ► CAJA / BOX

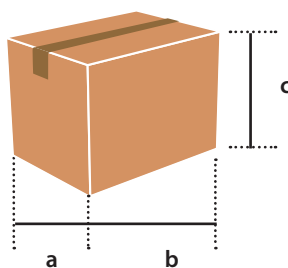

#### ► PALET / PALLET

