

SPECIFICATIONS

Key No.	Part No.	Description	Qty
1	01111100	Star-Shaped Nut	1
2	03042001	Bow-Shaped Metal Bar	1
3	01161006	Manhole Lid	1
4	02100006	Rubber Ring for Lid	1
5	08010044	Manometer Set for NL1200	1
5	08010045	Manometer Set for NL1400/NL1600	1
5	08010046	Manometer Set for NL1800/NL2000	1
5	08010047	Manometer Set for NL2300/NL2500	1
6	89012803	NL1200 Filter Tank With Base	1
6	89012809	NL1400 Filter Tank With Base	1
6	89012814	NL1600 Filter Tank With Base	1
6	89012819	NL1800 Filter Tank With Base	1
6	89012820	NL2000 Filter Tank With Base	1
6	89012830	NL2300 Filter Tank With Base	1
6	89012831	Filter Tank with Base for NL2500	1
7	89012804	The Inner Tank System for NL1200	1
7	89012810	The Inner Tank System for NL1400	1
7	89012815	The Inner Tank System for NL1600	1
7	89012823	The Inner Tank System for NL1800	1
7	89012824	The Inner Tank System for NL2000	1
7	89012834	The Inner Tank System for NL2300	1
7	89012835	The Inner Tank System for NL2500	1
8	89012807	Sand Drain Set	1
8	89012829	2.0" Sand Drain Set	1
9	89010107	Water Drain Set	1
10*	01172011	Laterals (233mm)	*
10*	01172010	Laterals (185mm)	*
10*	01172009	Laterals (129mm)	*

Notes: 10* NL1200 should have 185mm x 8pcs and 233mm x 8pcs and 129mm x 8pcs of laterals
 10* NL1400 should have 185mm x 4pcs and 233mm x 12pcs and 129mm x 12pcs of laterals
 10* NL1600 should have 185mm x 8pcs and 233mm x 12pcs and 129mm x 12pcs of laterals
 10* NL2000 should have 185mm x 8pcs; 233mm x 32pcs; 129mm x 8pcs of laterals
 10* NL2300/2500 should have 185mm x 40pcs; 233mm x 16pcs; 129mm x 48pcs of laterals

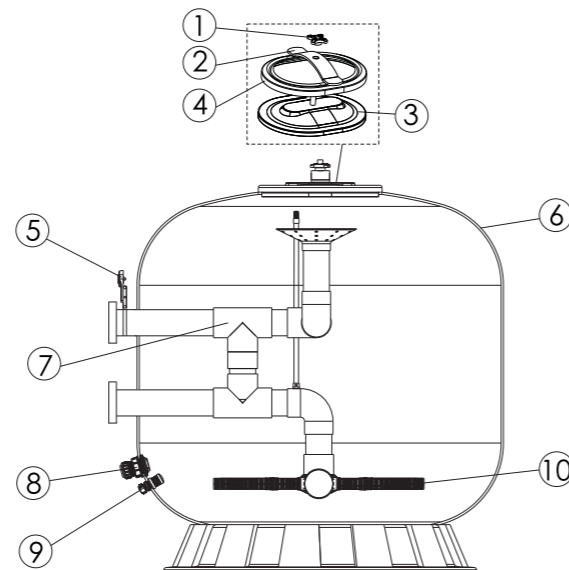

EMPTYING OF FILTER'S SAND

To change sand or filtration elements, proceed as follows:

- Remove top lid.
- Drain filter's water and sand through the lower drainage hole.
- If there is room, sand can be removed through the manhole.
- To refill the filter with sand, follow the instructions given in starting.

OTHER RECOMMENDATIONS

If the equipment has been stopped during a long period of time, it is advisable to empty the water filter.

- If the filter is situated outside, it is advisable to paint it with a suitable product every two years.
- In standard filters, Pressure and temperature specifications must not be exceeded. Contact our technical department if you have any doubt about the use of our filter.
- During the washing process, pressure must never exceed 1 kg/cm² for filters with plate with nozzles.
- Optionally, high performance filters can also be delivered with lateral manhole and sight glass, As well as special inner finishes of high maintenance quality and chemical resistance.

GUARANTEE

This filter has been manufactured using the best high technology materials and manufacturing process, going through strict quality tests on materials, finishes and performance.

All those bumps, rips and breakages caused by an inadequate use of the product or by ignoring our recommendations are not included in this guarantee.

The correct performance of the filter's tank and the internal components is guaranteed for 1 year.

These guarantees include only the replacement of defective parts. Further charges, as those works made by third parties, compensations, etc, will not be accepted by the manufacturer.

SAND FILTER

Models: NL1200 / NL1400 / NL1600 / NL1800 / NL2000 / NL2300 / NL2500

INTRODUCTION

This manual provides the necessary instructions to install, use and maintain bobbin wounded filters. In order to obtain the benefits that are indicated in the characteristics, all the instructions that appear in this manual must be followed. This will offer a safe and long-lasting installation. The equipment's supplier will provide further information to the user whenever it is needed.

DESCRIPTION

1) Description.

These filters have been designed to provide water filtration in pools and water parks, also for all water treatments that require the elimination of suspended matter using the proper reduction of filtration element.

Apart from the filter itself, filtration and depuration process include some points that must be taken into account as they can influence the correct filter operation. These would be chemical water treatment, pump equipment, pipe segments and general hydraulic design.

When public pools are concerned, the current rules in each country should be observed, as the installation must follow them.

The filtration quality depends on different parameters as depth of filtration bed, characteristics, quality and grade of filtration media, etc, as well as filtration rate.

2) Filter's Characteristics.

The tank is made of resin of polyester and glass fiber, totally anticorrosive. Inside, it contains collectors and diffusers made of unalterable plastic material (PVC and ABS), proof against salt-water. They are supplied for a working pressure of 2.5 kg/cm² to 4 kg/cm² and maximum temperature of 43°C. Other specifications can be supplied upon request. Filtration rates may be 20, 30, 40 and 50 m³/h/m², depending on the application and the kind of filtration elements that have been selected. Rate 50 is not advisable in public pools.

WORKING PROCESS

It has to be done with the pump stopped and valves in position.

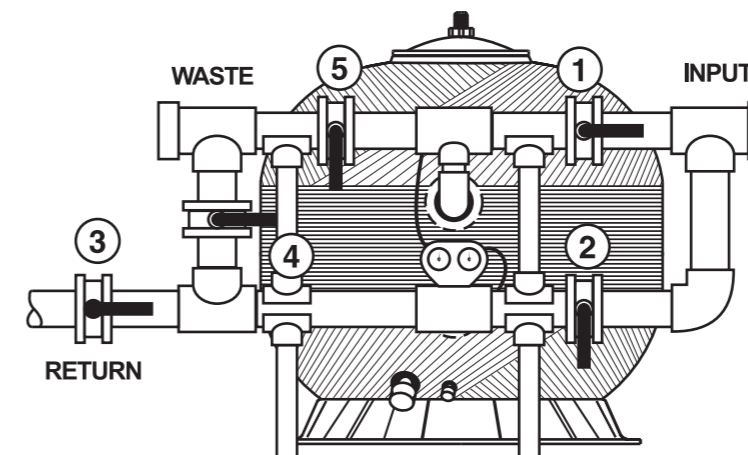

	①	②	③	④	⑤
FILTER	open	close	open	close	close
BACKWASH	close	open	close	close	open
RINSE	open	close	close	open	close
WASTE	open	close	close	close	open
RECIRCULATE	close	open	open	close	close

INSTALLATION

1) Filter installation

Filters are delivered properly packed and ready in order to facilitate unloading and transport using fork-lift truck, crane, etc. It is very important to make sure that the filters have not suffered bumps during transport.

To obtain a correct filter installation, the following stages must be observed:

- Install filters in their final location.
- Install correctly the butterfly valves in the filters.
- To connect with the flange of the filter, use PN1.6MPa or Class E 15bar PVC pipe.
- Install butterfly valves supports and regulate them correctly (height, etc.)
- Connect butterfly valves with the pipe of the pumps, return pipes and drain.
- Check the inner parts of each filter (collectors, top diffusers).
- Fill the filters with water.
- Empty half the water and add the filtration element (gravel, sand and/or anthracite), etc.

Instrument Panel installation:

- Before running the filter, drill a $\Phi 10$ diameter hole in the filter's return pipe. (Figure 1, Figure 2)
- Install the cushion onto the grey joint (Pay attention to the position of the cushion, the thin side of the cushion facing the joint). (Figure 3)
- After installed the cushion, put the joint into the $\Phi 10$ hole. Then put the metal ring over it and tighten the screw. (Figure 4, Figure 5)
- Screw on the white joint onto the grey joint (Ensure the white joint has an o-ring inside before installing). (Figure 6)
- Cut off pressure gauge rubber plug. (Figure 7)
- Twine the connection head with Teflon tape, fix to 1/4" thread and connect to the direct head and the valve of the panel. (Figure 8, Figure 9, Figure 10)

Caution:

- Tap with PN1.6Mpa or Class E 15bar PVC pipe.

1.1) Filters location.

It is acceptable to place the filters under the water level.

However if vacuum occurs in the installation, suction cups must be installed in the lids to avoid that depression could collapse the filter's tanks.

Filters must be situated so that their bases are perfectly level and completely supported by the floor. The location must be of appropriate size to allow maintenance periodic overhauls and other work. Additionally the room must provide a drain to allow, in case of accident, evacuation of water

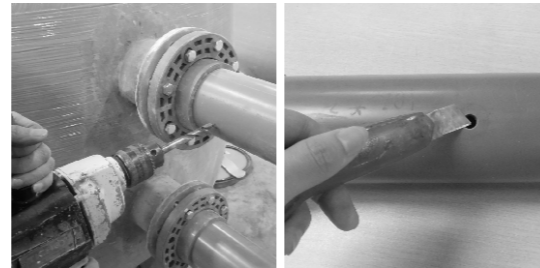

Figure 1

Figure 2

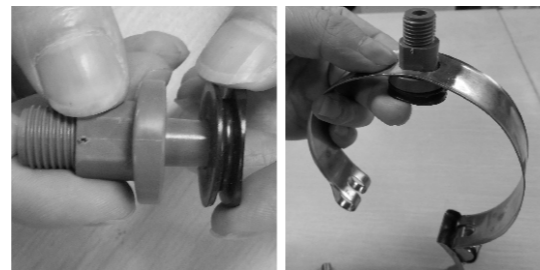

Figure 3

Figure 4

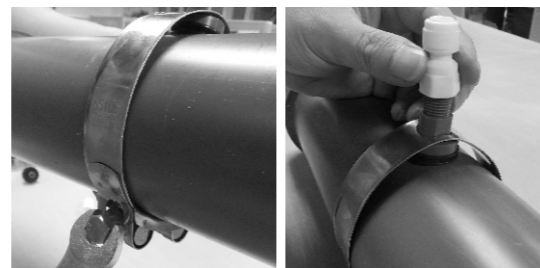

Figure 5

Figure 6

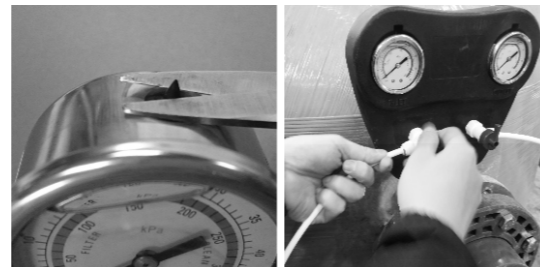

Figure 7

Figure 8

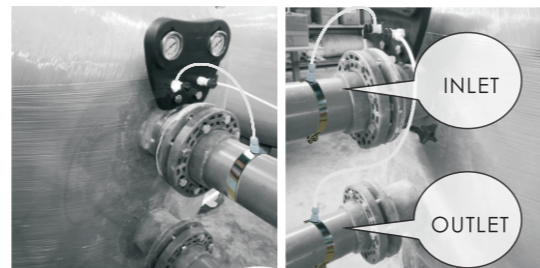

Figure 9

Figure 10

flowing from any tube, filter, pump, etc. this will avoid risk of damages in the electrical installations (pumps, electric panels, etc.)

1.2) Manometers.

The manometer panel had been installed in the filter. In pools filters, the usual pressures when the filter is clean are:

- Inlet pressure: 0.8-1 Kg/cm².
- Outlet pressure: 0.4-0.6 Kg/cm².

When the differential pressure between the two manometers is 1 Kg/cm² or higher, backwash must be carried out.

STARTING

Before filling filters with sand or other filtration elements, it is advisable to check the internal collectors to make sure that they have not been damaged during transport or installation. Afterwards, fill the filters with water and make hydraulic test. Thus, you will make sure that there is no leak and that the equipment works properly.

Then stop the pumps, open each filter's lid (the filter must not be emptied without opening the lid, as it could collapse) and empty half the water that each filter contains. Then, start filling the filter with sand or other filtration elements, taking into account that first of all you must put gravel up to the collector arms (10 cm approx.)

This must be done very carefully in order to avoid any damage in the lower components of the filter. When the filter is being filled with sand, this must be carefully spread over the surface.

Once the filter is full with the filtration elements clean the lid and the inner part of the manhole. This will prevent any debris and particles of sand affecting the seal of the joint.

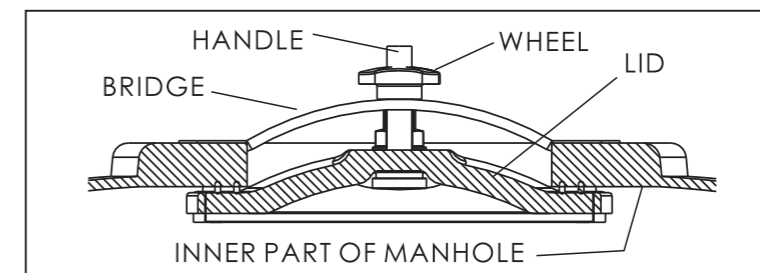

Introduce the lid in the manhole, leaving it leveled and centered. The lid must be supported by the handle, as this will avoid that it could fall into the tank and damage any of its parts.

Put the bridge in the position shown and tighten manually the wheel.

To achieve a proper seal, you do not have to tighten excessively the wheel, as this could damage the lid. The pressure itself will improve the seal.

When the filter is under pressure, it is normal that wheel and bridge remain separated. You must not tighten the wheel again when the filter is under pressure, because when the pumps stop, the lid could be damaged or blocked.

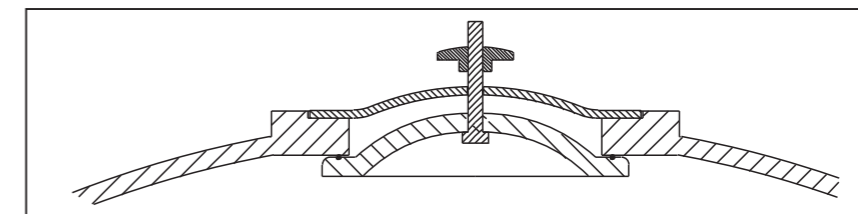

Once the filter has been completely filled with water, start the performance of installation, venting manually to eliminate all the air that could be inside the filter, as the presence of air impairs the filter performance.

If a vacuum forms in the filters, it is necessary to install double effect suction cups, these will also act as automatic air purifiers and would avoid that the tank could collapse.

After this, the filter has been ready for working process.