

► SKIMMER 15 L PISCINA HORMIGÓN / SKIMMER 15 L CONCRETE POOL

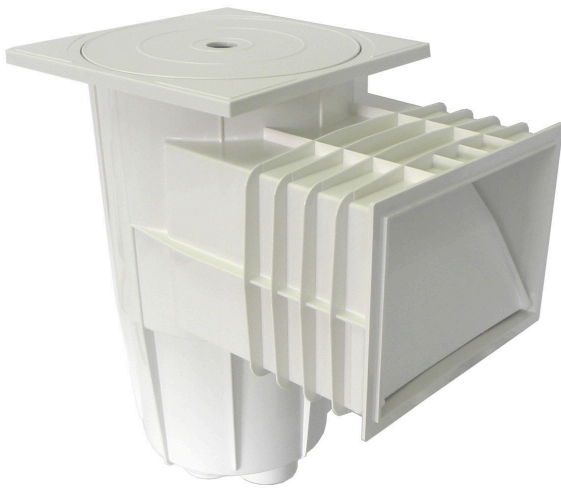

00250



00251

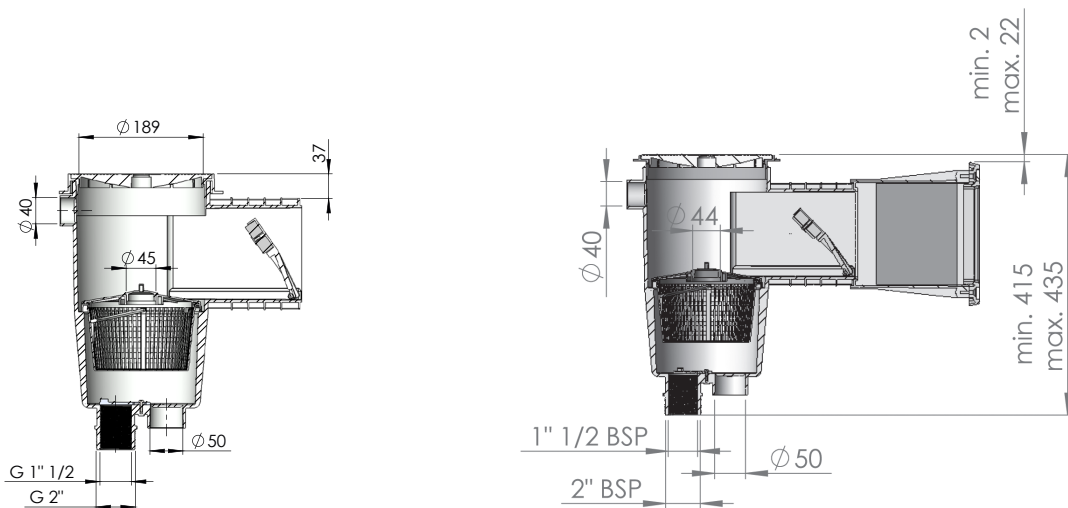
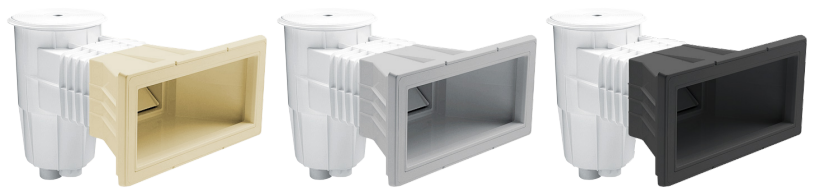
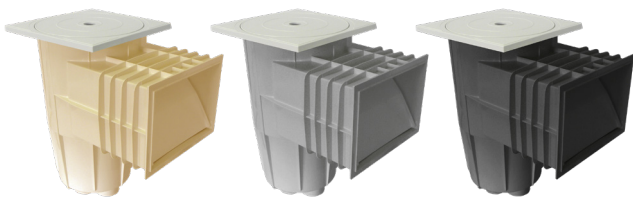













DESCRIPCIÓN DEL PRODUCTO / PRODUCT DESCRIPTION

Todos los skimmers de la gama tienen tratamiento UV en las partes que no quedan enterradas. Fabricados en ABS blanco, con flotador de compuerta y clapeta para regulación de caudal. Conexión inferior de aspiración: rosca int. 1 1/2", ext. 2". Conexión simultánea al sumidero: Ø int. 50. Conexión superior de evacuación de agua sobrante Ø 40. Cesto recogehojas. Caudal recomendado 5 m<sup>3</sup>/h. Se recomienda instalar un skimmer por cada 25 m<sup>2</sup> de superficie de lámina de agua.

*All exposed skimmer parts are UV resistant. In white ABS with silent wier flap and flow regulation plug. 1 1/2" female - 2" male suction connections. Ø 50 mm solvent connection also provided. Overflow connection Ø 40 mm. Basket secured to base with bayonet fixing. Recommended flow 5 m<sup>3</sup>/h. We recommend installing one skimmer for every 25 m<sup>2</sup> of water surface area.*

## ► CARACTERÍSTICAS TÉCNICAS / TECHNICAL CHARACTERISTICS

CARACTERÍSTICAS / CHARACTERISTICS	00249	00250	00251	00252
<b>Tipo de boca</b> <i>Type of throat</i>				
<b>Forma tapa</b> <i>Lid form</i>				
<b>Rosca int. (conexión inferior)</b> <i>Thread int. (bottom connection)</i>	1 1/2"	1 1/2"	1 1/2"	1 1/2"
<b>Rosca ext. (conexión inferior)</b> <i>Thread ext. (bottom connection)</i>	2"	2"	2"	2"
<b>Conexión superior</b> <i>Top connection</i>	Ø 40	Ø 40	Ø 40	Ø 40
<b>Caudal recomendado</b> <i>Recommended flow rate</i>	5 m <sup>3</sup> /h	5 m <sup>3</sup> /h	5 m <sup>3</sup> /h	5 m <sup>3</sup> /h
<b>Superficie recomendada</b> <i>Recommended surface</i>	cada 25 m <sup>2</sup> <i>every 25 m<sup>2</sup></i>	cada 25 m <sup>2</sup> <i>every 25 m<sup>2</sup></i>	cada 25 m <sup>2</sup> <i>every 25 m<sup>2</sup></i>	cada 25 m <sup>2</sup> <i>every 25 m<sup>2</sup></i>
<b>Colores</b> <i>Colours</i>				

## ► LOGÍSTICA / LOGISTICS

### EMBALAJE Y PALETIZADO / PALLETIZED AND PACKAGING

Código - Code	00249 - 00250			00251 - 00252		
	a	b	c	a	b	c
<b>Medidas caja (mm) - Box sizes (mm)</b>	428	260	377	587	452	436
<b>Unidades / Caja - Units / Box</b>	1			1		
<b>Volumen / Caja (m<sup>3</sup>) - Volume / Box (m<sup>3</sup>)</b>	0,044			0,116		
<b>Peso / Caja (Kg) - Weight / Box (Kg)</b>	2,4			4,47 - 5		
Medidas palet (mm) - Pallet sizes (mm)	a	b	c	a	b	c
	1000	1200	2150	1000	1200	2300
<b>Unidades / Palet - Units / Pallet</b>	54			20		
<b>Volumen / Palet (m<sup>3</sup>) - Volume / Pallet (m<sup>3</sup>)</b>	2,58			2,76		
<b>Peso / Palet (Kg) - Weight / Pallet (Kg)</b>	144,6			97,96 - 108,56		

#### ► CAJA / BOX

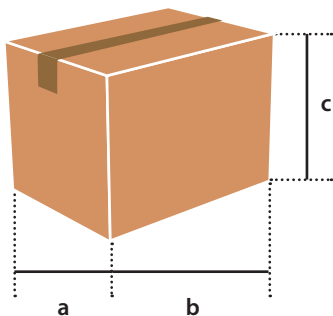

#### ► PALET / PALLET

