



LumiPlus FlexiNiche projector

The LumiPlus FlexiNiche projector is an underwater floodlight that can be fitted on niches from 180 mm to 235 mm in diameter. It is fitted in three easy steps: the spotlight is selected first of all, then the model of niche to which it will be attached and finally the faceplate.

The spotlight is available in two power modes: V1 for private pools and V2 for public and hotel pools. For each power mode, there is a choice of cool white, warm white and RGB multicolor light. The multicolor versions are compatible with the ECO, TOP, wireless, LumiPlus LED app, ModBUS (Connect) and DMX controllers (see codes).

The faceplate can be made of ABS in a white, light gray, anthracite gray or beige finish, or of AISI 316 stainless steel.



TECHNICAL SPECIFICATIONS

VOLTAGE:	12 V AC (24 V DC in according to model)
FREQUENCY:	50/60 Hz
SERVICE LIFE:	L70-50,000 h
MAX. WATER TEMPERATURE:	40 °C
MAX. INSTALLATION DEPTH:	2 m (wireless RGB projectors: max. 0.5 m)
MAXIMUM WATER TREATMENT VALUES:	Chlorine: 2 mg/l Bromine: 5 mg/l Salt chlorinator (NaCl): 6 g/l Pool water pH: 7.2 and 7.6
CABLE	2.5 m. H07RN-F 2 x 1 mm ² Cables from 5 to 30 meters long are available (see codes).
MATERIALS:	Polyamide
COMPATIBLE ACCESSORIES/NICHES:	00349, 59813, 00364, 17805, 28887, 72261 59814, 23671, 23670, 59815.

Spotlight

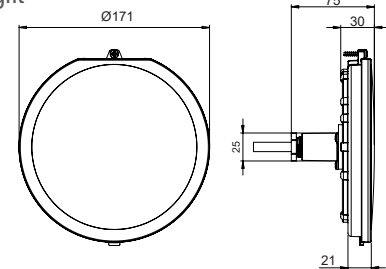



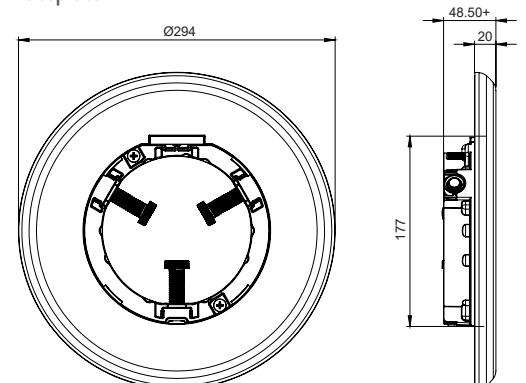





Faceplate



* measurements in mm.



LUMIPLUS V1	71236	71200 71212	71200WW	71201 71213	71201WW	71203	71205 *
TYPE OF LIGHT	WHITE	WHITE	WARM WHITE	WHITE	WARM WHITE	RGB 	WIRELESS RGB
VOLTAGE	24 V DC	12 V AC	12 V AC	24 V DC	24 V DC	12 V AC	12 V AC
POWER	8,7 W	14,5 W	14,5 W	14 W	14 W	22 W	22 W
CONSUMPTION	8,7 VA	20 VA	20 VA	14 VA	14 VA	29 VA	29 VA
LUMINOUS FLUX	1.485 lm	1.485 lm	1.485 lm	1.485 lm	1.485 lm	1.100 lm	1.100 lm
COLOR TEMP.	5.700 K	5.700 K	3.000 K	5.700 K	3.000 K	-	-
CRI >	70	70	80	70	80	-	-
LUMINOUS EFFICIENCY	171	102	102	106	106	50	50
FLUX ANGLE	100°	100°	100°	100°	100°	100°	100°
LENS	Wide	Wide	Wide	Wide	Wide	Wide	Wide
THERMAL PROTECTION	Flasher	Flasher	Flasher	Flasher	Flasher	Flasher	Flasher
ENERGY CLASS <small>As per UE 2019/2015</small>							
INSTALLATION IN SALT WATER	Yes	Yes	Yes	Yes	Yes	Yes	Yes
COMPATIBLE CONTROL SYSTEMS	ON/OFF	ON/OFF	ON/OFF	ON/OFF	ON/OFF	32458, 27818, 41988, 59131, 57434	59125, 64633

* FLEXI Wireless sets available:

1 Flexi spotlight + 1 Control Motion = **71206**

2 Flexi spotlights + 1 Control Motion = **71207**



Fluidra Connect compatible

PHOTOMETRIC MEASUREMENTS

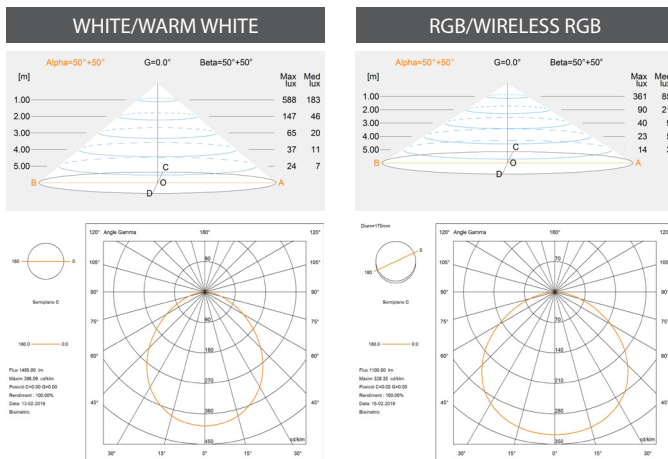







FACEPLATES



* Made of ABS with an AISI 316 stainless steel outer cover

PACKAGING



LUMIPLUS V2	71233	71233WW	71202	71202WW	71204	71208
TYPE OF LIGHT	WHITE	WARM WHITE	WHITE	WHITE	RGB 	RGB DMX
VOLTAGE	12 V AC	12 V AC	24 V DC	24 V DC	12 V AC	12 V AC
POWER	32 W	32 W	32 W	32 W	43 W	43 W
CONSUMPTION	42 VA	42 VA	32 VA	32 VA	54 VA	54 VA
LUMINOUS FLUX	4,320 lm	4,320 lm	4,320 lm	4,320 lm	2544 m	2,544 lm
COLOR TEMP.	5,700 K	3,000 K	5,700 K	3,000 K	-	-
CRI >	70	80	70	80	-	-
LUMINOUS EFFICIENCY	135	135	135	135	59	59
FLUX ANGLE	100°	100°	100°	100°	100°	100°
LENS	Wide	Wide	Wide	Wide	Wide	Wide
THERMAL PROTECTION	Flasher	Flasher	Flasher	Flasher	Flasher	Flasher
ENERGY CLASS <small>As per UE 2019/2015</small>						
INSTALLATION IN SALT WATER	Yes	Yes	Yes	Yes	Yes	Yes
COMPATIBLE CONTROL SYSTEMS	ON/OFF	ON/OFF	ON/OFF	ON/OFF	32458, 27818, 41988, 59131, 57434	41107, 74099, 74100

 Fluidra Connect compatible

PHOTOMETRIC MEASUREMENTS

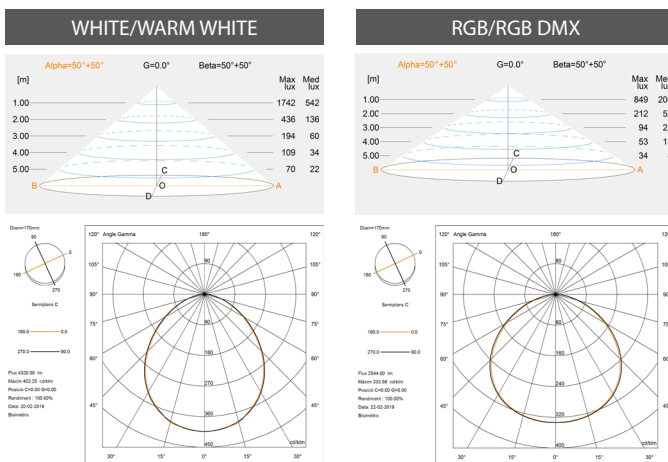

PACKAGING AND PALLETIZATION

Code	71200, 71200WW 71203, 71205 71233, 71233WW 71204, 71208	71201 71201WW	71206 71202 71202WW	71207
Single box size (mm)	117 x 192 x 222		117 x 245 x 245	100 x 415 x 210
Volume/Single box (m ³)	0.005		0.007	0.008
Weight/Single box (kg)	0.73	0.84	0.89	1.43
Units/Standard box	5		4	2
Volume/Standard box (m ³)	0.03			
Weight/Standard box (kg)	4.2	4.75	4.11	3.41
Units/Pallet	280		224	64
Volume/Pallet (m ³)	2.46			
Weight/Pallet (kg)	250.2	281	245.16	124.12

MULTIPLE BOX
