

thermecro

ELEGR0
ENGINEERING

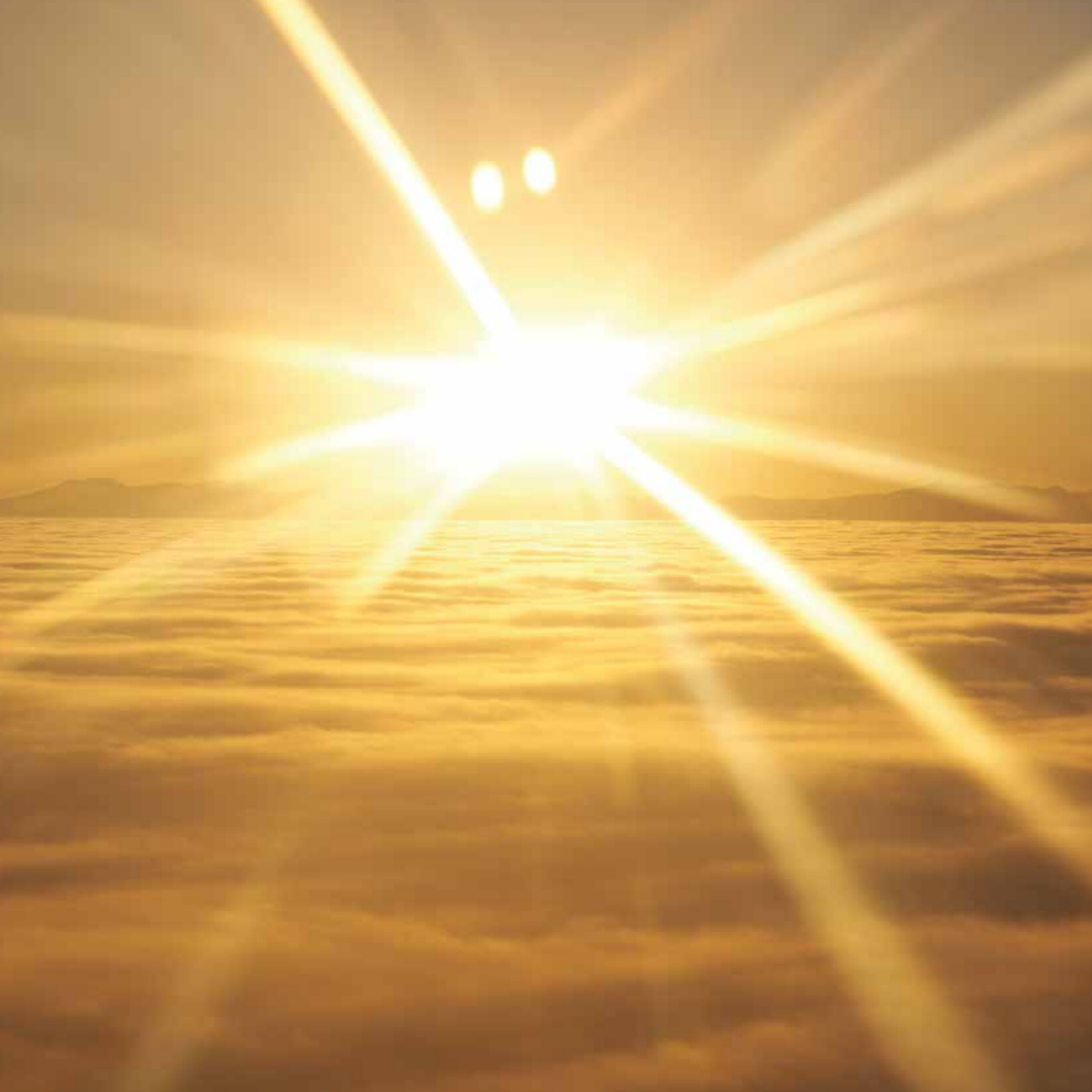

POWERFUL, PATENTED TECHNOLOGY

The most powerful source of heat in our solar system is the sun; if one third of the Sahara desert was covered by solar collectors it will surpass the entire world's energy requirement. Thermecro converts a staggering 92% of solar radiation that strikes it into hot water for your swimming pool or spa. Thermecro is not reliant on outside temperatures or direct sunlight so, unlike any other solar heaters on the market, it will work optimally in all weather conditions, temperatures and locations.

The Key benefits are:

- Significantly reduces your energy consumption
- The most efficient solar harvesting device known to mankind
- Achieves significantly higher temperatures than any other solar collectors
- Works by collecting solar radiation, not just direct sunlight
- Eco-Friendly reduces your carbon footprint
- Stores hot water with virtually zero heat losses

Over the lifetime of a typical 32 tube Thermecro system we would expect an approximate saving to be made of £11,200 GBP, based on today's average price of electricity.

Thermecro with its own patented technology is far superior to conventional systems, collecting 92% of solar radiation in evacuated tubes, similar to a vacuum flask, to ensure that all of the heat collected is not lost or wasted and delivered to your pool or spa.

Conventional solar systems for pools will absorb solar radiation, but will also lose a significant amount of heat especially when air temperatures are low, as these systems cannot be sufficiently insulated from climatic conditions, while Thermecro is perfectly insulated so no heat is lost.

Thermecro is designed for easy installation into any pool or spa system. The tube array is arranged tightly together and mounted within an adjustable frame to achieve maximum energy yield, within the smallest possible footprint.

With energy prices continually rising, and the onus on us as individuals to conserve our planets resources, now is the time to consider how Thermecro can reduce your energy bills and help to preserve our environment.

PRODUCT OVERVIEW

- **Revolutionary:** Evacuated tube technology has the highest efficiency for harvesting solar radiation by processing all solar radiation striking from any angle, not just direct sunlight. The system boasts the highest heat retention rate possible as the evacuated tubes do not allow heat to escape.
- **Eco-Friendly Solution:** Thermecro uses solar radiation to heat your pool /spa system whilst emitting zero CO₂ emissions.
- **Efficient:** The solar rack harvests 92% of available solar radiation in all weather conditions. The tubes convert the solar radiation whether it is diffused, reflected or direct.
- **Space-Saving:** Thermecro is optimally designed to achieve the maximum output from the smallest possible footprint.
- **Reliable:** Thermecro is built to last, constructed from materials such as; Titanium, Glass and Polymer Alloys. It can be coupled to any system, including salt and sea water systems.
- **Cost-effective:** Thermecro uses no external power to generate hot water, so offers financial savings from the first day of installation.
- **Easy Installation:** Using the supplied installation kit, Thermecro can simply be plumbed into any existing pool or spa filtration circuit.

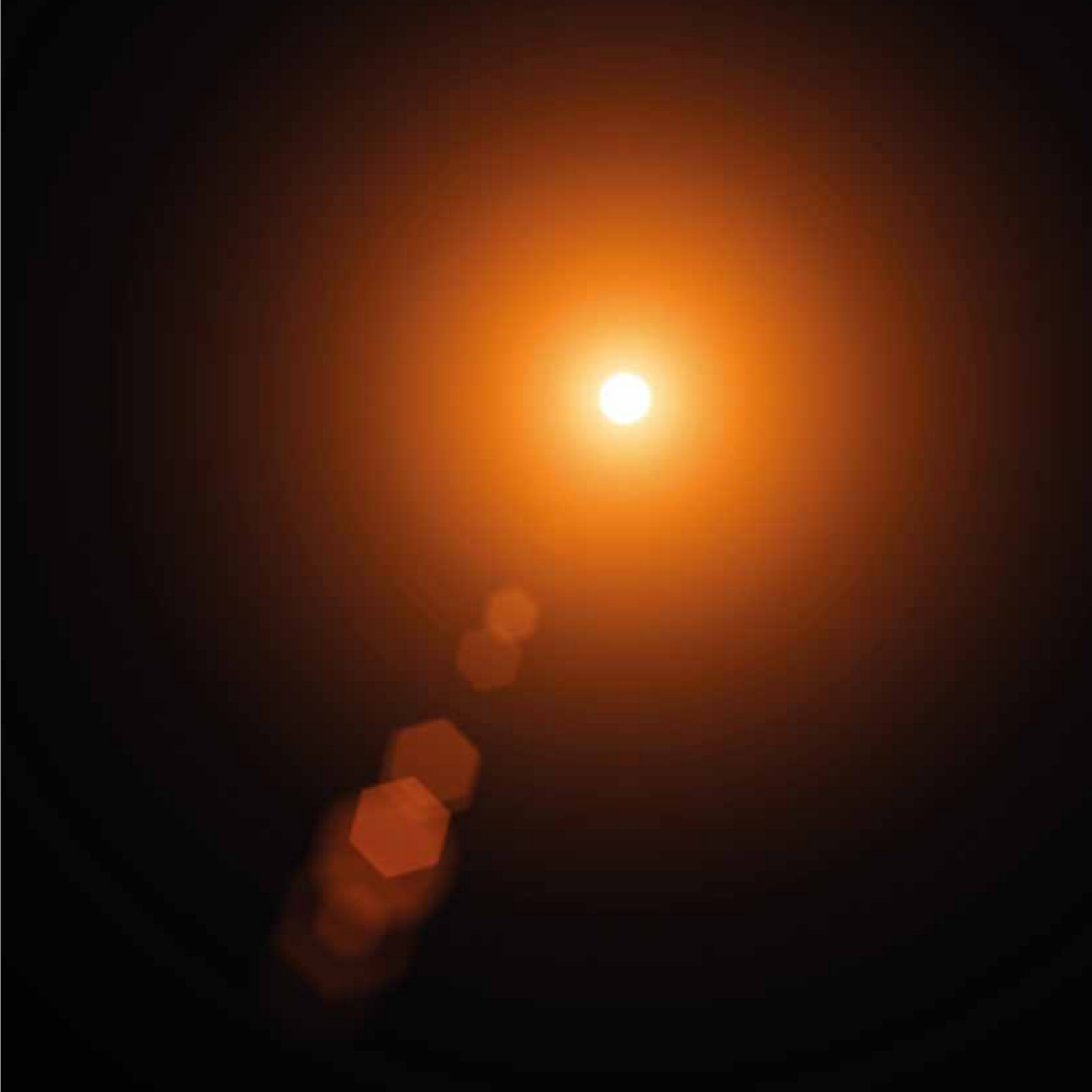

WHY SOLAR HEATING?

The first successfully demonstrated solar collector was in 1767 by a Swiss scientist, Horace de Saussure. The idea of using Solar Power as an energy source was not pursued until recent times, simply because fossil fuels were readily available and very affordable.

During the late 20th century our approach to energy consumption started to shift. Fossil fuel shortages coupled with an increasing demand by mankind, led to ever increasing fuel prices, giving a financial incentive to look for alternative sources of energy. The discovery that burning fossil fuels emits CO₂ and other gases into our atmosphere are causing damage to our planet has added to the drive for more Eco-Friendly energy sources. Many types of renewable energy sources exist, Solar PV, Wind, Biomass, Hydroelectric to name a few. For the pool and spa industry only one type offers free energy at point of delivery that is reliable, consistent and has absolutely no emissions and that is Solar Heating.

Conventional pool or spa solar heating systems such as capillary matting or flat plate collectors are not efficient in all conditions, for example when air temperature is lower than the water temperature, as none of these systems can be sufficiently insulated. They do not generate high enough water temperatures for spa installations. Finally, conventional systems require a significantly larger coverage area to operate.

THERMECRO ADDRESSES INDUSTRY ISSUES:

- Thermecro generates far more hot water per m² than any other solar heating system
- The system is perfectly insulated so delivers hot water to your pool or spa with zero losses
- Thermecro works even in the lowest of ambient temperatures
- Thermecro is the only system that can heat water to sufficient levels for spas
- Thermecro is compact in comparison to all other solar heating systems

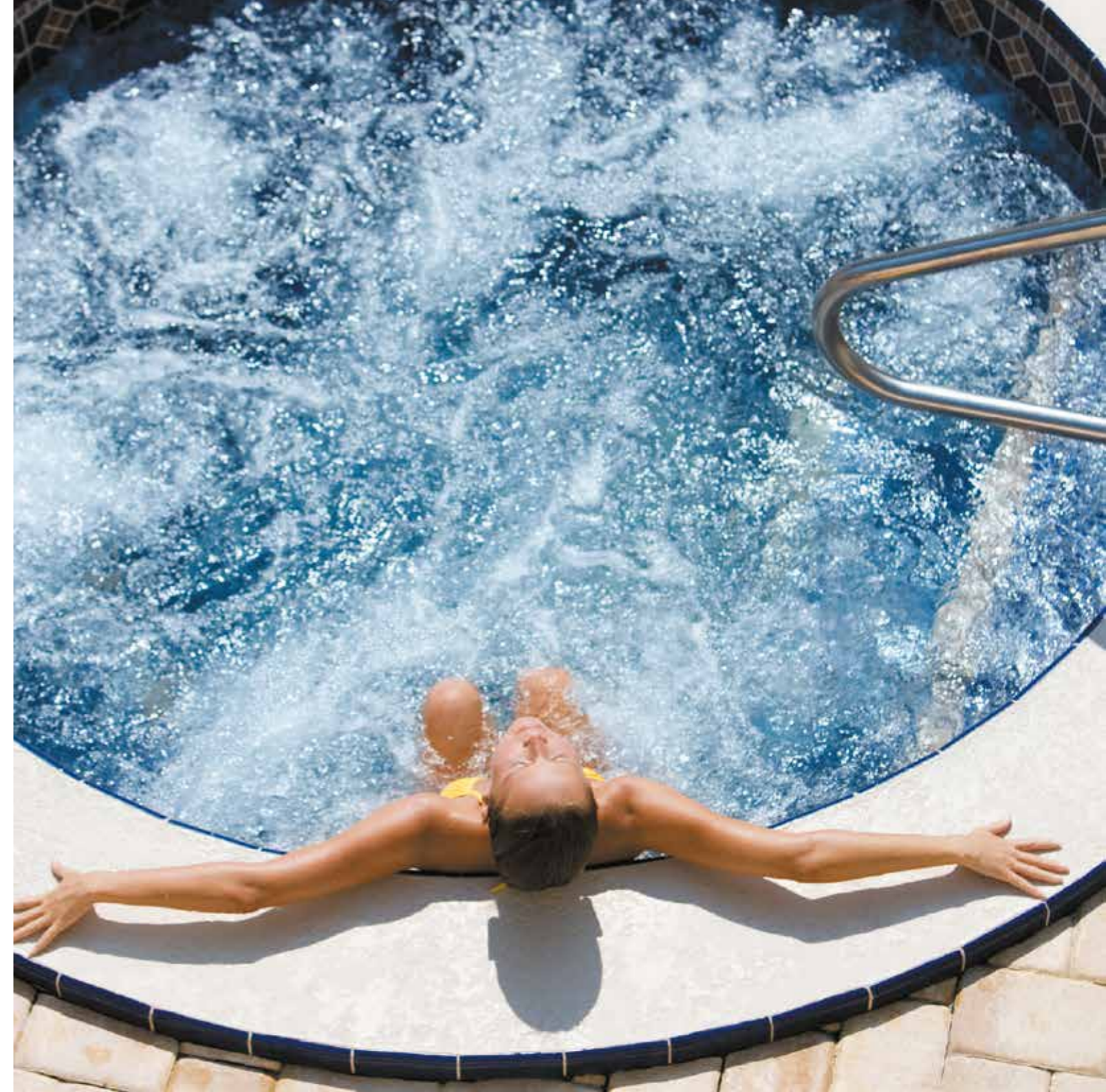

HOW DOES IT WORK?

Thermecro has uniquely adapted evacuated tube technology rendering it the most efficient solar heater collector available. Thermecro tubes will collect solar radiation and turn this into hot water no matter what the ambient temperature. The tubes, frame and manifold system are designed specifically for use with pools and spas and offer a long life, even in a hostile environment. As you would expect Thermecro is suitable for all pool types including sea and salt water installations, the tubes have three key components:

- 1) The tubes are made from very strong, low reflectivity, borosilicate glass. A key feature is that each tube has its own vacuum with a barium getter [vacuum indicator] incorporated, and this increases performance with a visual indicator of the tubes integrity. The vacuum tube insulates your heated water from the ambient air temperature and allows the system to deliver all of the hot water generated to your pool or spa throughout the year.
- 2) A special coating within the tube generates hot water from solar radiation absorbed during daylight hours and even produces high efficiency in overcast conditions, unlike capillary matting or flat plate collectors. This heat is transferred to water in the central cavity of the tube.
- 3) Each Thermecro tube contains a Titanium capillary to draw hot water from the hottest part of the solar tube, through the supply and return manifold, into your pool or spa.

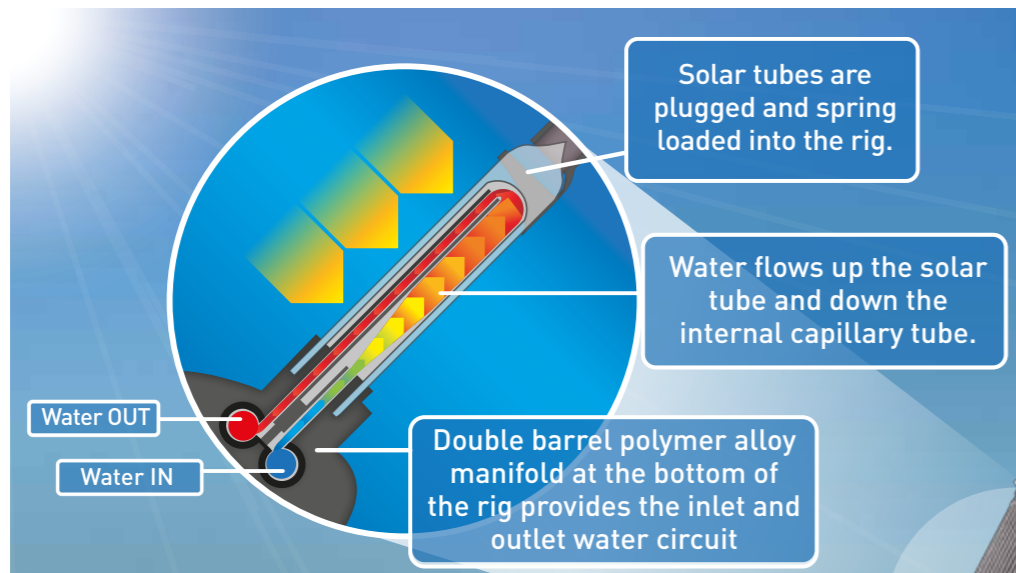

In the images [below] we show three types of solar collectors on a typical roof installation: - Photovoltaic, Flat Plate Collectors, with Evacuated tubes shown on the extreme right. In the thermal image Photovoltaic and Flat Plate Collectors are glowing yellow and red, thus showing they are losing heat, the Evacuated tubes are blue showing that no heat is being lost.

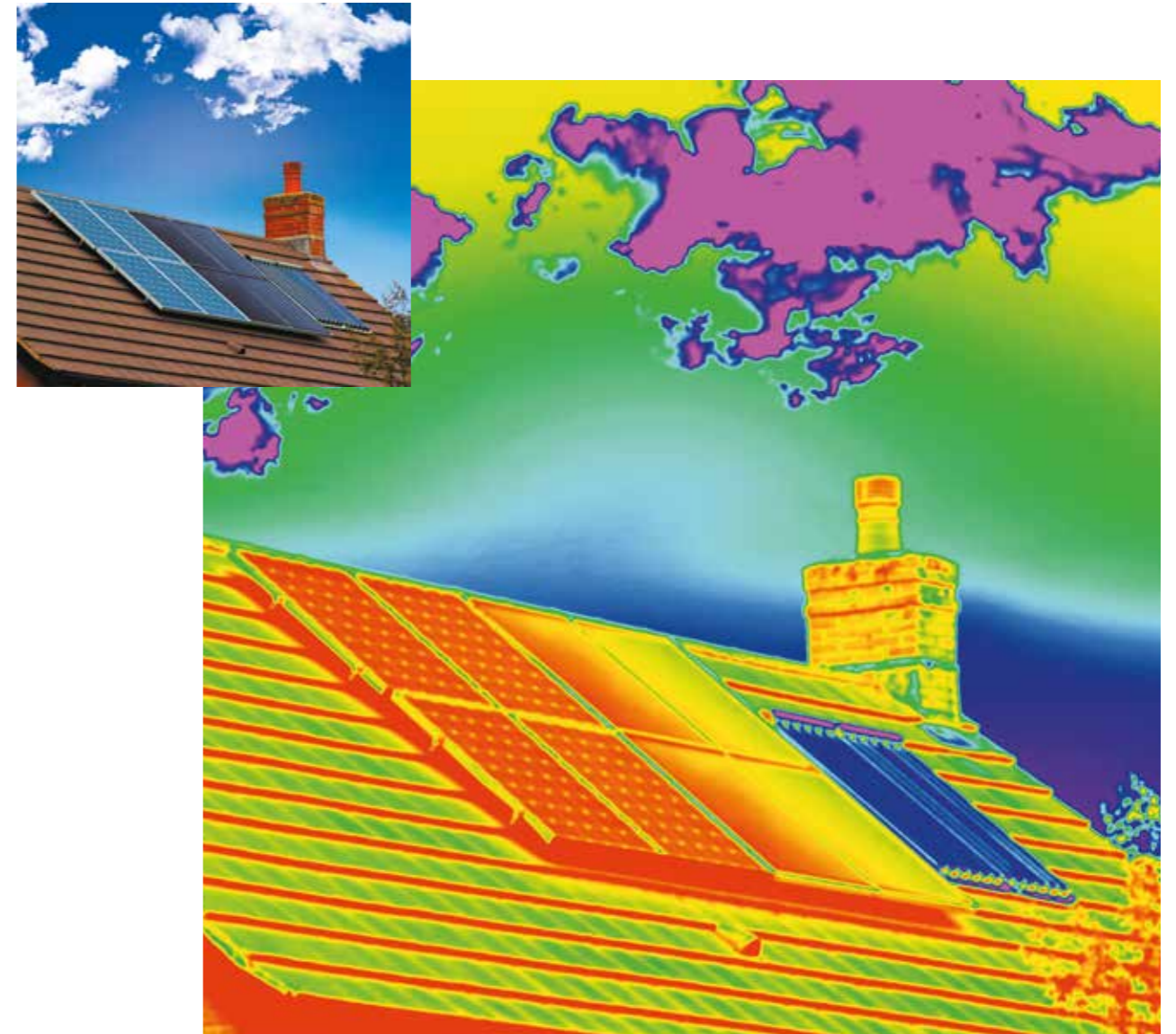

INSTALLATION AND SIZE GUIDE

The Thermecro solar system is available in 16, 32 and 48 tube racks and can be easily installed into your existing set-up. Use the simple sizing guide below to help choose the ideal system for you.

Firstly choose your Solar Zone using the temperature and clear day calculator below.

Average Midday Air Temperature [summer]	% of Days With Clear Sky's		Your Solar Zone
22°C	60%	=	A
24°C	70%	=	B
26°C	80%	=	C

Now compare your Solar Zone to the surface area of water in your pool to arrive at a suggested Thermecro Tube Array that is suitable for you.

Your Solar Zone	16 Tube Rack	32 Tube Rack	48 Tube Rack
A	14m ²	28m ²	42m ²
B	19m ²	39m ²	59m ²
C	27m ²	53m ²	82m ²
Dimensions 'W'	1124mm	2148mm	3180mm

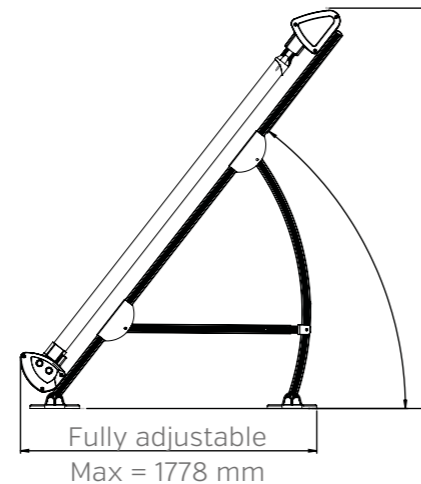
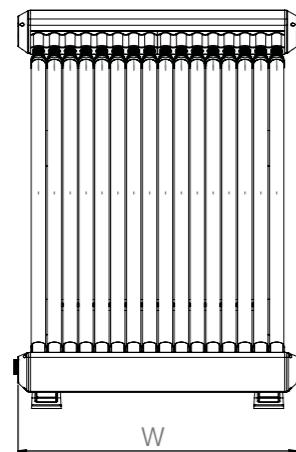

Fully adjustable
Max = 1241 mm

TECHNICAL SPECIFICATION

Evacuated Radiation Collector Tubes			
Material	Borosilicate 3.3 [Pyrex]		
Dimensions	1500mm x 58mm		
Frame Material		Anodised Aluminium 3mm Wall Sections	
Water Connections	1" BSP Male Thread [x2 Pairs]		
	16 Solar Tubes	32 Solar Tubes	48 Solar Tubes
Installed weight	109 KG	216 KG	325 KG

POOL LAYOUT

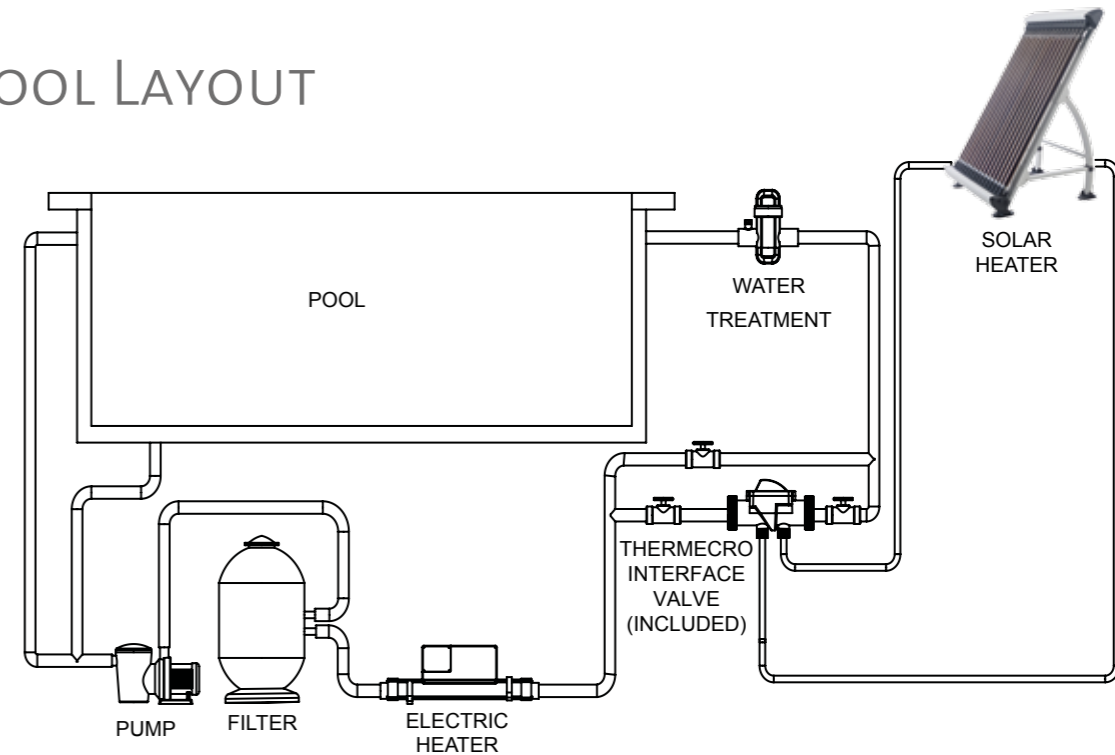

thermecro
BY ELECRO

www.elecro.co.uk

Unit 11 Gunnels Wood Park, Gunnels Wood Road,
Stevenage, Hertfordshire, SG1 2BH, United Kingdom

T: +44 [0]1438 749 474 | F: +44 [0]1438 361 329 | E: sales@elecro.co.uk