

POOL & SPA VACUUM CLEANER

(English)

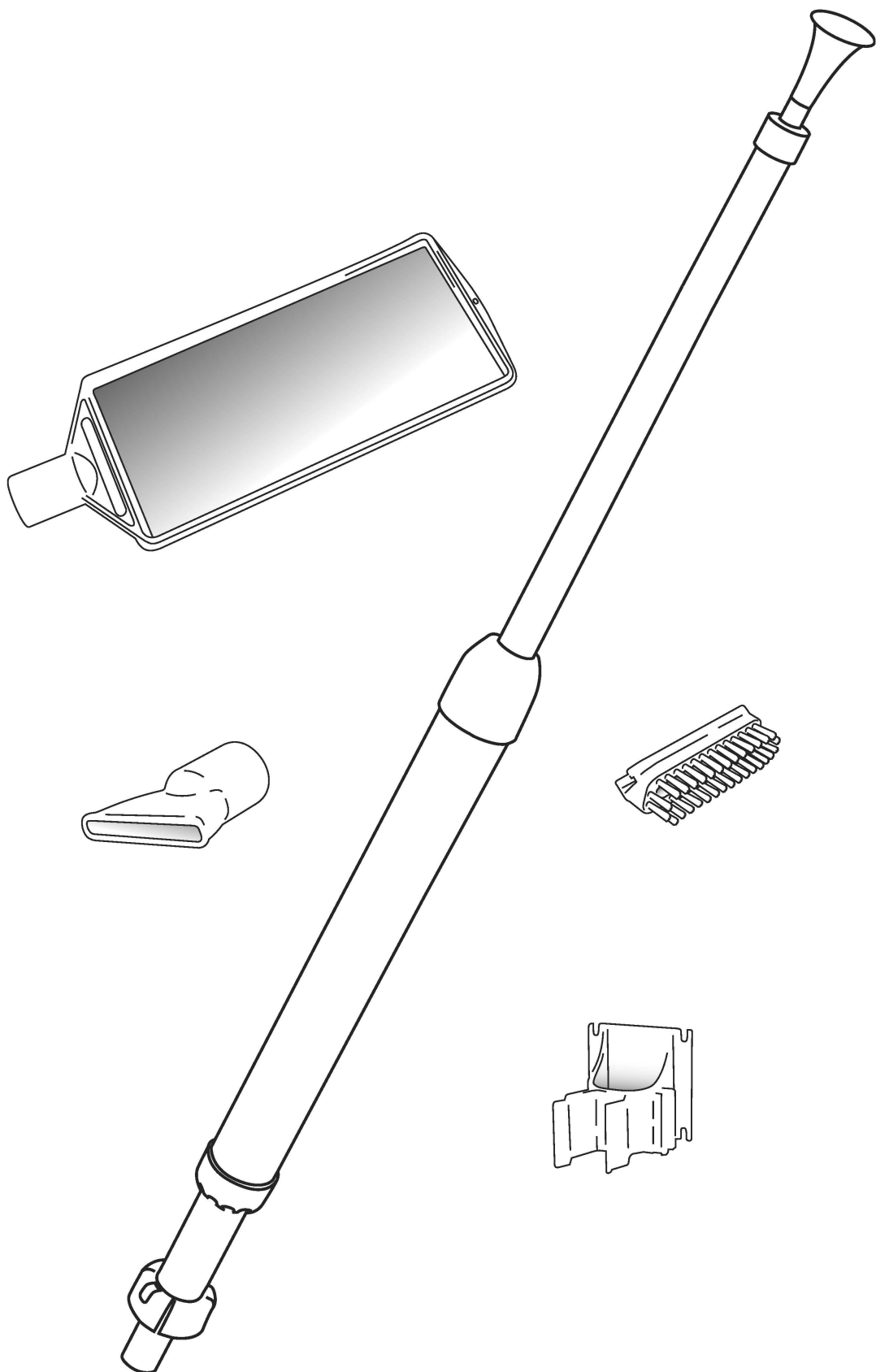

ASSEMBLY INSTRUCTIONS

Main Unit

Upper Piston Rod - Part 1
 Lower Piston Rod - Part 2
 Upper Tube - Part 3
 Lower Tube - Part 4

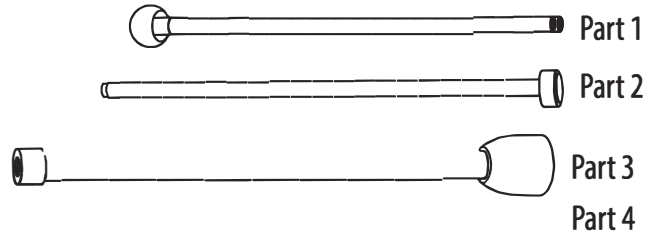

Accessories

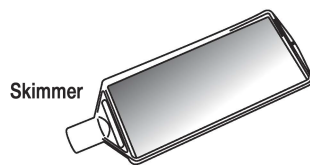
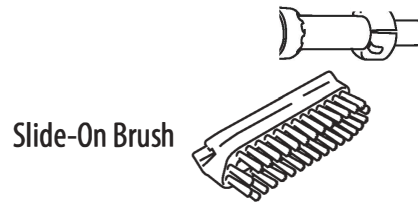

1. Insert Upper Piston Rod (Part 1) completely into Upper Tube (Part 3) if it is not already in place when removed from box.

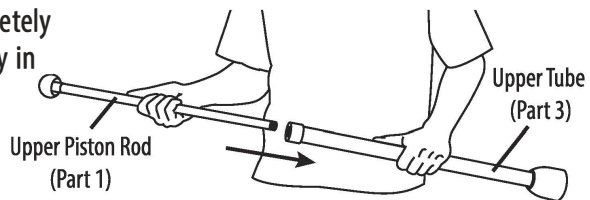

2. Attach Lower Piston Rod (Part 2) by screwing it into Upper Piston Rod (Part 1).

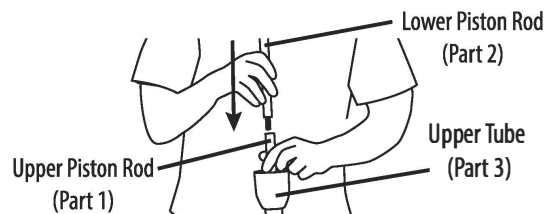

3. Gently position the bottom Lower Piston Rod (Part 2) into the gray opening of the Lower Tube (Part 4). Slide the Upper and Lower Tubes together gently. Lower Tube screws into Upper Tube. Start threading the tubes together slowly. If you are having difficulty assembling the tubes, using liquid soap on threads will help.

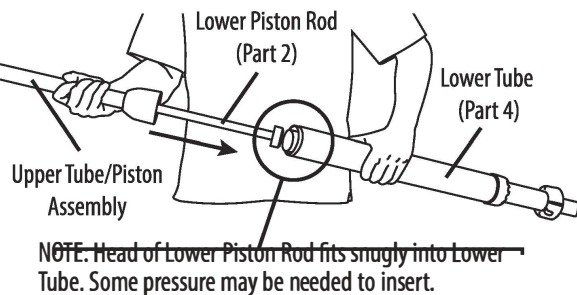

4. Completed vac is ready to go!

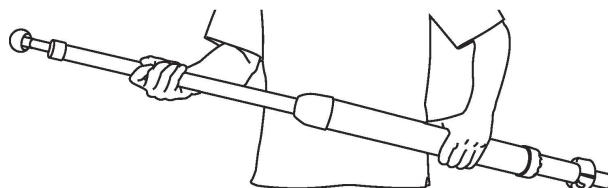

USE AND CLEANING INSTRUCTIONS

The Pool & Spa Vacuum simplifies all your spa and pool needs. Cleanup is easy - the simple pump action creates suction that draws in water and debris from the pool or spa as you pull the handle out. Push the handle in and the dirt and debris are trapped inside the special filter basket as the water flows out. The vacuum requires no special hoses or hookups. It comes with a Narrow Nozzle (attached), a Wide End Nozzle (attaches to the Narrow Nozzle) and a specially designed Slide-On Brush.

CAUTION: DO NOT SCRAPE VACUUM OR NOZZLES AGAINST ACRYLIC SPAS AS THIS WILL DAMAGE THE SURFACE OF THE SPA.

CLEANING YOUR SPA OR POOL

Always start by priming the unit by placing the nozzle end of the Vacuum underneath the surface of the water. Pump the unit's handle in and out several times to remove air that may be trapped in the Vacuum. Always begin with the handle pushed completely in. Pull the handle out to draw debris in. • Use the Narrow Nozzle to remove rocks and debris.

- To remove dirt, attach the Wide End Nozzle to the Narrow Nozzle.
- Slide the Brush onto the Wide End Nozzle to scrub stubborn dirt spots.

EMPTYING THE FILTER BASKET (See illustrations below)

1. Twist and pull the Narrow Nozzle to remove.
2. Grasp the plastic band at the base of the screen. **DO NOT GRASP THE FILTER BASKET SCREEN!** Gently rotate the Narrow Nozzle counterclockwise until you feel it stop.
3. Gently pull the Filter Basket from the nozzle. Empty the basket and rinse clean with water.
4. Replace the basket on to the nozzle and turn clockwise to lock it into position.

NOTE: ALWAYS DRAIN EXCESS WATER FROM THE UNIT AFTER USE BY REMOVING THE FILTER UNIT.

