

Robotic Pool Cleaner

For Commercial - Public Swimming Pools

Operator Manual

Robot limpiapiscinas

Para piscinas públicas y privadas

Manual de operación

Schwimmbeckenreiniger

Für kommerzielle und öffentliche Schwimmbäder

Bedienungsanleitung

Robot pulisci-piscine

Per piscine pubbliche e private

Manuale di utilizzo

Robot nettoyeur

Pour piscines publiques et privées

Manuel d'utilisation

Robot Aspirador

Para piscinas públicas e privadas

Manual de funcionamento

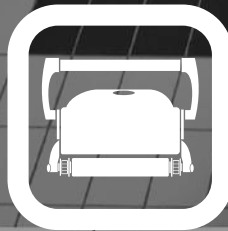

Content

1. BEFORE USING YOUR POOL CLEANER	PAGE 7
2. PROGRAMMING YOUR POOL CLEANER	PAGE 11
3. SETTING THE OPERATION TIME	PAGE 11
4. SETTING THE DELAY TIME	PAGE 12
5. CLEANING LEVEL	PAGE 12
6. POOL FEATURES	PAGE 13
7. USING THE REMOTE CONTROL	PAGE 14
8. INFORMATION MODE	PAGE 17
9. MAINTENANCE AND ADJUSTMENT	PAGE 21
10. TROUBLESHOOTING GUIDE	PAGE 22
11. AQUA KART	PAGE 26

Indice

1. ANTES DE UTILIZAR SU LIMPIAPISCINAS	PÁGINA 31
2. PROGRAMACIÓN DEL LIMPIAPISCINAS	PÁGINA 35
3. AJUSTE DEL INTERVALO DE FUNCIONAMIENTO	PÁGINA 35
4. AJUSTE DEL TEMPORIZADOR	PÁGINA 36
5. NIVEL DE LIMPIEZA	PÁGINA 36
6. FUNCIONES DEL LIMPIAPISCINAS	PÁGINA 37
7. USO DEL CONTROL REMOTO	PÁGINA 38
8. MODO DE INFORMACIÓN	PÁGINA 41
9. MANTENIMIENTO Y AJUSTE	PÁGINA 45
10. RESOLUCIÓN DE PROBLEMAS	PÁGINA 46
11. AQUA KART	PÁGINA 50

Inhaltsverzeichnis

1. VOR DEM GEBRAUCH	SEITE 55
2. PROGRAMMIERUNG	SEITE 59
3. EINSTELLEN DER REINIGUNGSZEIT	SEITE 59
4. EINSTELLEN DER VERZÖGERUNGSZEIT	SEITE 60
5. AUSWAHL DES REINIGUNGSGRADES	SEITE 60
6. AUSWAHL DER BECKENEIGENSCHAFTEN	SEITE 61
7. BENUTZEN DER FERNBEDIENUNG	SEITE 62
8. INFORMATIONSMODUS	SEITE 65
9. INSTANDHALTUNG UND VORSCHRIFTEN	SEITE 69
10. HANDBUCH FÜR FEHLERSUCHE	SEITE 70
11. TRANSPORTWAGEN	SEITE 74

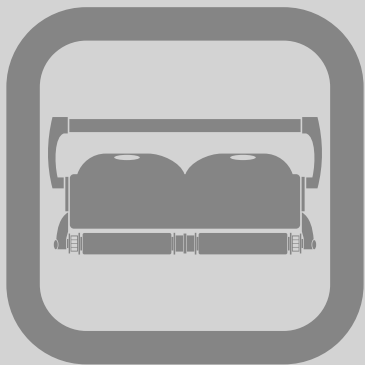

Robotic Pool Cleaner

For Commercial - Public Swimming Pools

Operator Manual

IMPORTANT SAFETY INSTRUCTIONS
READ AND FOLLOW ALL THE INSTRUCTIONS

CAUTION: Turn the Power supply off and unplug it from power outlet before carrying out user maintenance such as cleaning the filter.

Do not plug the power supply into a grounded outlet or do not switch the pool cleaner “ON” if it is not fully immersed in water. Operating the cleaner out of water will cause severe damage immediately and will result in loss of warranty.

Allow the cleaner to remain in the pool for 15 to 20 minutes following the end of its cleaning cycle. This will allow the motors to cool adequately. Do not leave the cleaner in the pool all the time. Always remember to turn the power supply “OFF” and unplug it from the power outlet before removing the cleaner from the pool.

WARNING: The cleaner must not be used when people are in the water. For use with swimming pool only

Safety Note

- The unit must be supplied through a residual current device (RCD) having a rated residual operating current not exceeding 30 mA
- The connection to the branch circuit should be consistent with the local and national wiring rules (electrical code).
- Mishandling of the unit can result in leakage of lubricants.
- If the supply cord is damaged, it must be replaced by the manufacturer’s service agent or a qualified and trained person in order to avoid hazards.



This appliance can be used by children from 8 years and above and persons with reduced physical, sensory or mental capabilities, or lack of experience and knowledge if they have been given supervision or instruction concerning use of the appliance in a safe way and understands the hazards involved. Children shall not play with the appliance. Cleaning and user maintenance shall not be made by children without supervision.



WARNING: A Ground Fault Current Interrupter (GFCI-USA) or a Residual Current Device (RCD-EUROPE) must be installed to protect your electric outlet and prevent any possible electric shock.

SAVE THESE INSTRUCTIONS

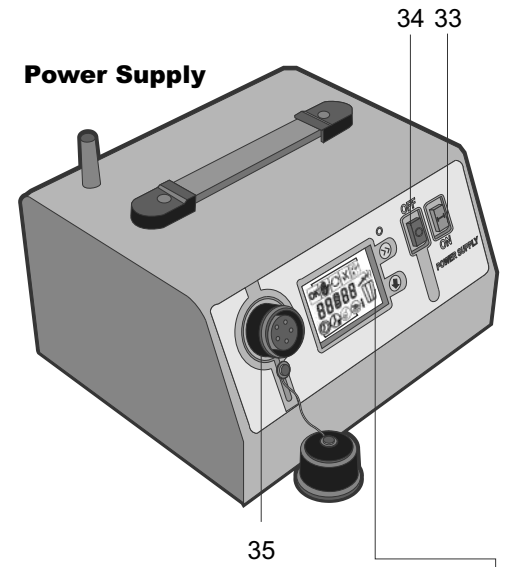
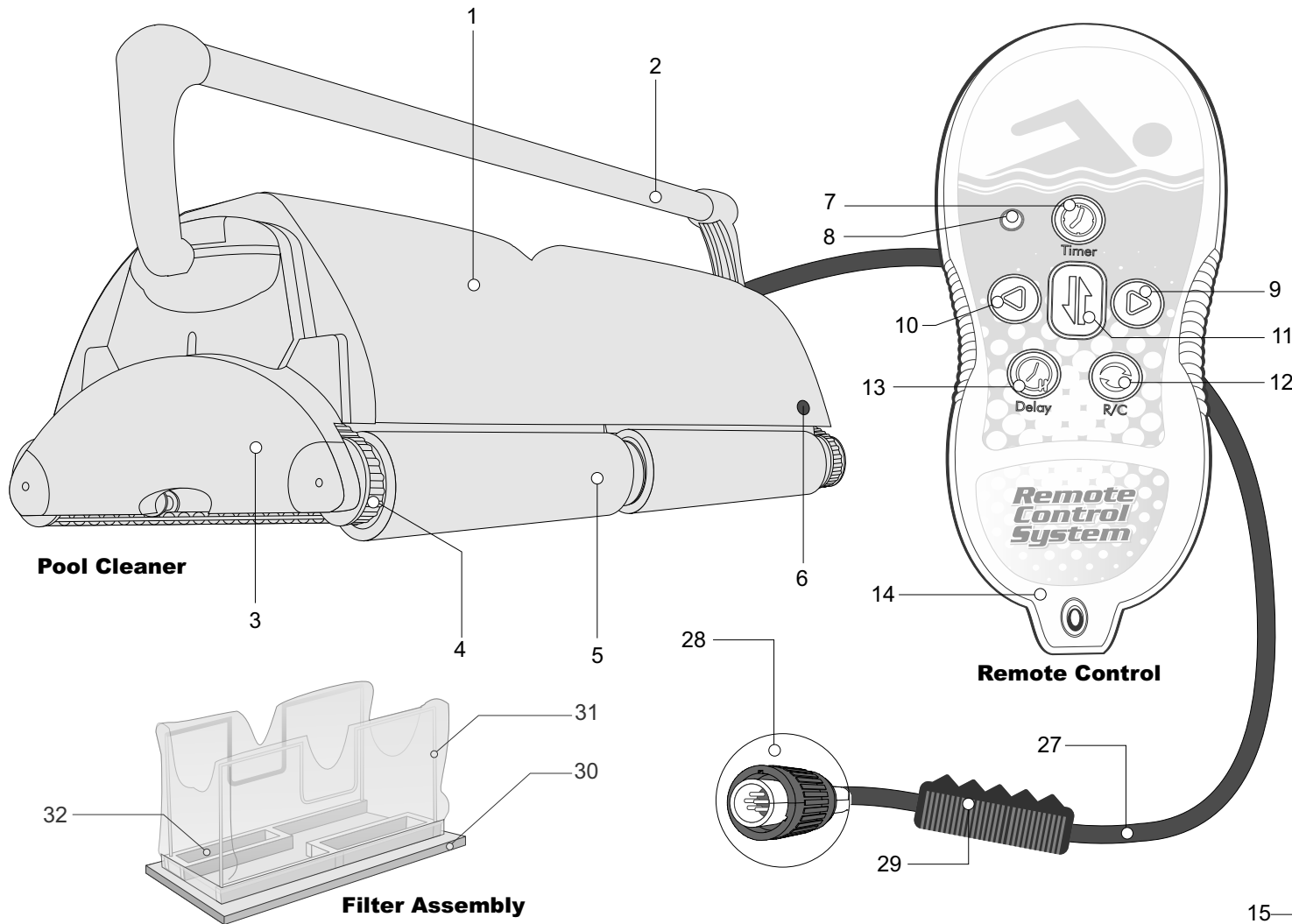

Robotic Pool Cleaner
For Commercial - Public Swimming Pools
COMPONENTS OVERVIEW

Pool Cleaner

- 1. Unit Body
- 2. Handle
- 3. Side Plate
- 4. Drive Track
- 5. Wheel Tube and Brushes
- 6. Infrared Sensor

Remote Control

- 7. timer button
- 8. LED
- 9. right turn button
- 10. left turn button
- 11. change direction button
- 12. remote control mode button
- 13. delay button
- 14. remote control transmitter

Control Panel

- 15. Operation Time
- 16. Init. Mode
- 17. Delay Mode
- 18. Cleaning Mode
- 19. OK/Error indication
- 20. Test Mode
- 21. Full Bag
- 22. Information
- 23. Select Pool Features
- 24. Select Cleaning Type
- 25. Select Delay Time
- 26. Select Cleaning Cycle

Floating Cable

- 27. floating cable
- 28. plug (transformer to unit)
- 29. E-Z Swivel

Filter Assembly

- 30. Bottom lid assembly
- 31. Filter bag
- 32. Intake valve flaps

Power Supply

- 33. ON Button
- 34. OFF Button
- 35. Socket

1. Before using your pool cleaner

Location of the Power Supply Unit (Transformer)

The power supply unit should be placed in any sheltered area, at least 3 meters (10 feet) away from the swimming pool. Additionally, the power supply should not be left out in rain or placed in puddles of water. If possible, place the power supply half the distance of the length of the pool. (fig.1) This will allow the cable and the unit to reach any corner of the pool. The enclosed power supply is configured for ONE of the following inputs:

a) 115 V b) 230 V

Make certain that the sticker on the back of the transformer corresponds with the correct voltage input .

WARNING!!

- 1) A ground fault current interrupter (GFCI in USA) or a residual current device (RCD- Europe) must be installed to protect your electrical outlet and to prevent the possibility of electrical shock.
- 2) Unit should not be operated in water temperatures above 94 degrees F (35 degrees C)
- 3) Store unit in protected area with a minimum temperature of 55 degrees F (12 degrees C) to prevent damage to internal seals.

Important Tips

- Shut off and unplug the power supply every time you remove the cleaner from the water.
- Clean the filter bag after every cycle.
- Periodically straighten out the floating cable.
- Replace worn brushes to ensure maximum cleaning performance.
- Save your cleaner's packaging for off-season storage or for shipping the unit to your dealer if service is required.
- Leave your pool cleaner in the water for 15 to 20 minutes after every cleaning cycle.
- Do not leave your cleaner in direct sunlight when not in use.
- Never leave the power supply in direct sunlight and avoid leaving it in the rain.
- Occasionally, you should rinse your cleaner including the Lock Tabs and intake valves on the Bottom Lid Assembly in clean, fresh water. This will lengthen the service life of the drive belts, drive tracks and scrubbing brushes.
- Clean the propeller once a month (see *MAINTENANCE AND ADJUSTMENT*)

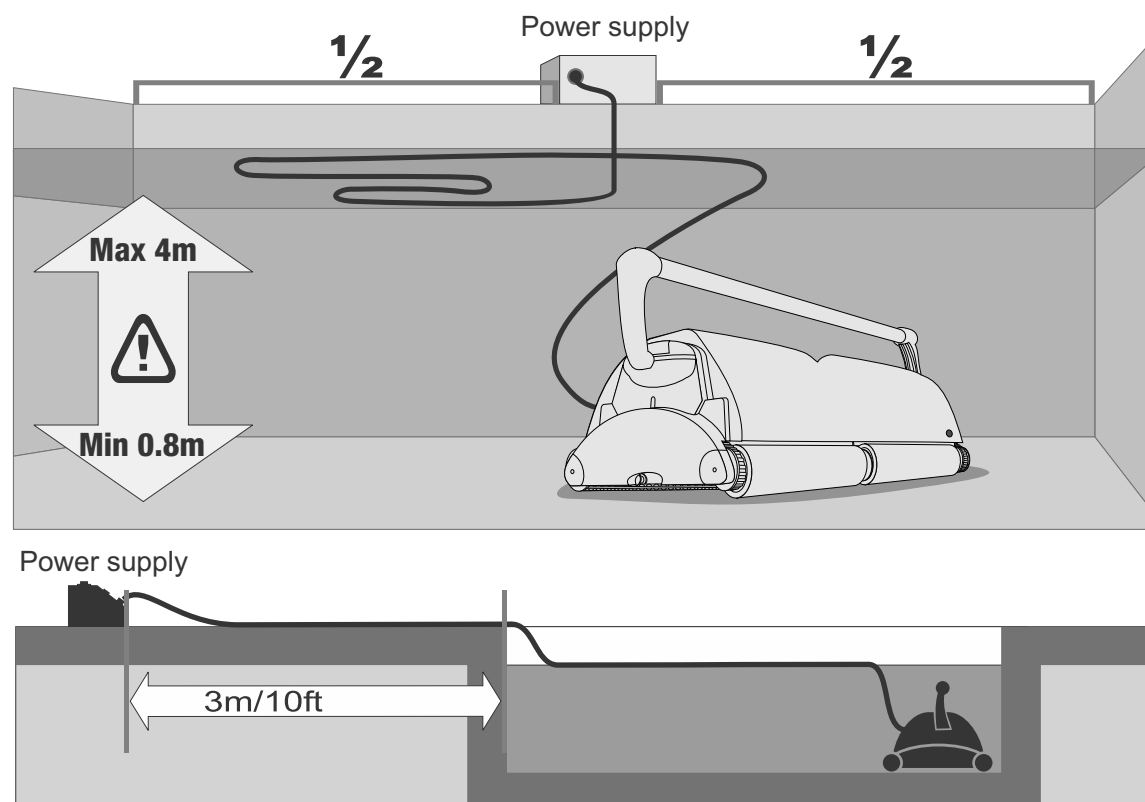

Fig. 1

To Operate Your Pool Cleaner

- 1) Plug the pool cleaner cable into the power supply. Make sure the key on the plug corresponds exactly with the key slot on the socket of the power supply (fig. 2)
 - 2) Completely immerse the cleaner in water.
 - 3) While the pool cleaner is in the water, gently tilt it side to side (fig. 3). This will allow any trapped air to escape through the pump outlets. Then, with a gentle push, allow the cleaner to sink to the bottom of the pool.
- NOTE: If the pool cleaner does not sink to the bottom of the pool, it's a result of trapped air. This air must be removed for proper operation (Repeat step 3).
- 4) Uncoil the floating cable fully and spread it over the pool water surface as evenly as possible. Make sure the cable has no tangles or kinks. (fig. 1)
 - 5) Plug the power supply into a proper grounded outlet. (verify the proper voltage again). Switch ON the power supply. The pool cleaner will start to operate and clean the pool in accordance with the cleaning program that you choose. For details see next page.

Removing the unit from the pool

1. Pull the unit by the floating cable until the unit is close to the surface and the attached Rope Assembly is within your reach.
 2. Turn the unit until the brushes are close to the wall.
 3. With both hands, grasp the loop at the end of the Rope Assembly and gently pull or lean backwards to lift the far side of the unit from the water. This will allow the water to drain from the robot.
 4. When the water has drained, grasp the handle with both hands and lift the unit from the water.
- CAUTION:** Bringing the unit side plate next to the pool wall and using the handle to lift the far side from the water for draining may cause severe damage to the Handle Assembly.

correct

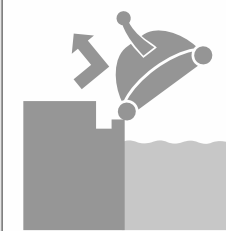

wrong

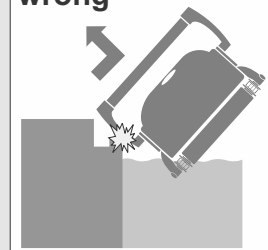
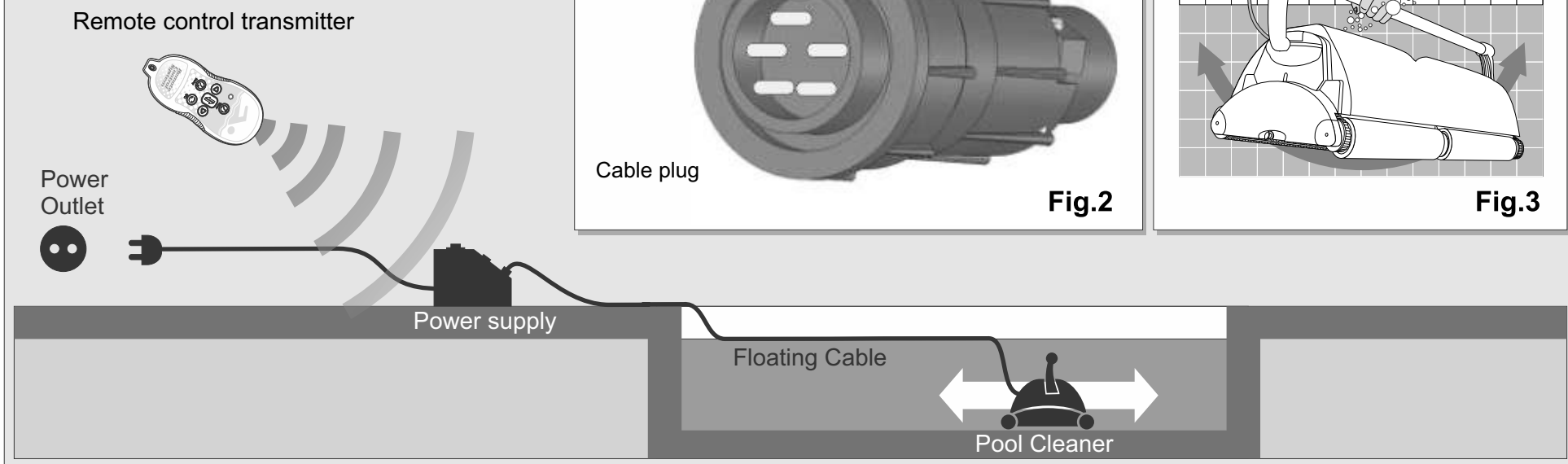
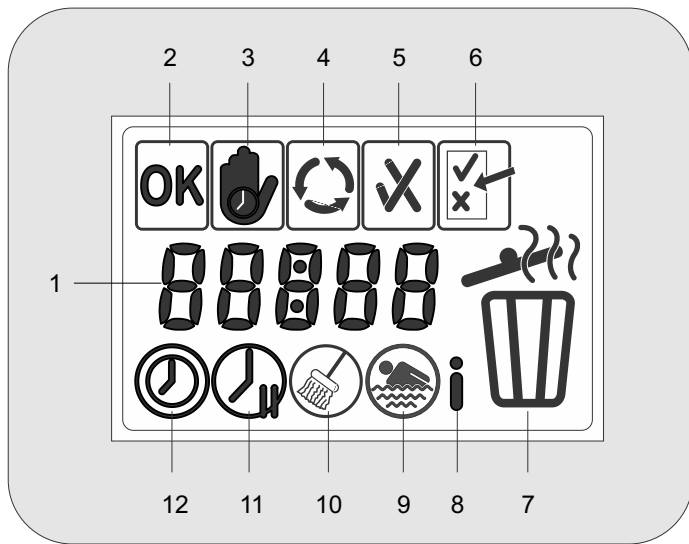

Fig.4





Control Panel

- 1. Operation Time
- 2. Initial Mode
- 3. Delay Mode
- 4. Cleaning Mode
- 5. OK/Error indication
- 6. Test Mode
- 7. Full Bag
- 8. Information
- 9. Select Pool Features
- 10. Select Cleaning Type
- 11. Select Delay Time
- 12. Select Cleaning Cycle

Power OFF (Red)
Shuts Off the Pool Cleaner

Power ON (Green)
Starts the Pool Cleaner

Control Panel

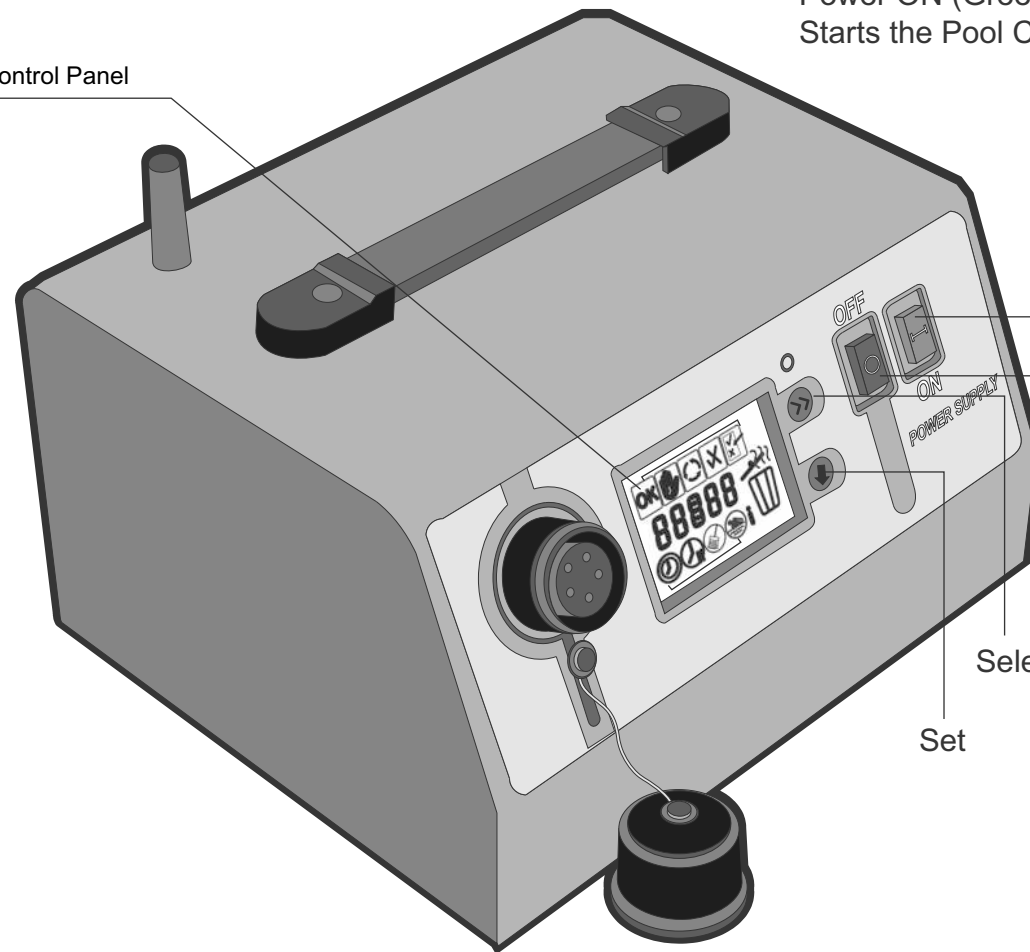

Select

Set

The Power Supply

The new Power Supply allows you to program your Robotic Cleaner for:





- Operating time
- Pool length
- Surface material
- Required cleaning level

You can also select the required time delay before the start of the Cleaning Cycle. The Power Supply LCD Display provides information about faults, total working hours and operation details of the last Cleaning Cycle.

To protect the control panel (LCD display) do not leave the power supply in direct sunlight or exposed to rain.

Programs and Functions

Operator Indicator



	Initial Mode	Indicates that the Robotic Cleaner is ready to use; no faults detected.
	Delay Mode	Indicates whether the Robotic Cleaner is in Delay Mode: <ul style="list-style-type: none"> • Indicator is lit: Robotic Cleaner is in Delay Mode. • Indicator is not lit: regular operation, Robotic Cleaner is not in Delay Mode.
	Cleaning Mode	Rotates to Indicate that Robotic Cleaner is in Cleaning Mode. The Robotic Cleaner- cleans for a predefined period according to the current Cleaning 3, 4 & 6 hours.
	OK/Error Indication	OK (✓) Previous Cleaning Cycle completed successfully Error (X) Failure occurred during the previous Cleaning Cycle.
	Test Mode	For Technicians only

Display



Operation Time – hh:mm
Standby Time – hh:mm
Cleaning Type, Pool Length,
Information and Error Codes.

Programming Indicators – Active set up parameters

	Select	Pressing the Select button enables the user to select programming mode, while paging between program modes.
	Set	Pressing the Set button sets the selected value while paging between the options.

2. Programing your pool cleaner

Programming

The Robotic Cleaner is shipped with the following manufacturer default values:

Cycle Time	3 hours
Delay Time	No delay
Cleaning Level	Regular
Pool Length	50m
Pool Type	Rough Ceramic

- The Robotic Cleaner will operate according to the manufacturer default values unless those values are manually changed (see “Programming the Robotic Cleaner”).
- Programming values are stored in the Power Supply memory even after the Robotic Cleaner is shut off (Power OFF).

Use the following procedure to program your Robotic Cleaner:

A. PRESS THE GREEN POWER “ON” BUTTON UNTIL YOU HEAR A CLICK; OK flashes for four seconds and then disappears (the Power Supply runs a self-test).

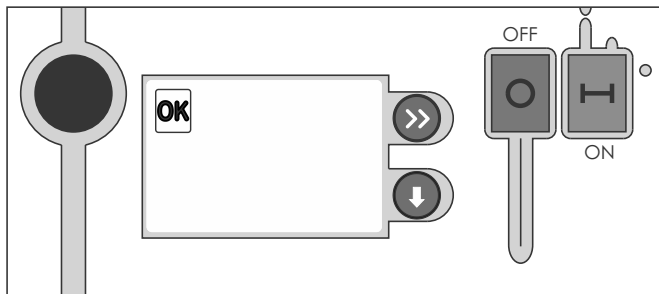



Note: Programmed values are stored in memory. Therefore the Robotic Cleaner will always start working according to last programmed values.

B. IF THE (X) SYMBOL APPEARS, A FAILURE HAS OCCURRED. See the Error code in the information page .

3. To set the operation time

Set the Cycle Time according to the amount of debris in the pool. Increase the Cycle Time accordingly.

a) Press Select  . The Cycle Time indicator  and the Time Display 03:00 both flash.

b) Press Set  until the desired Cycle Time is displayed.

For example, press twice to display a Cycle Time of 7 hours.

c) Press Select 

- the Time Display stops flashing and the Cycle Time is set.
- the next programming mode appears on the display.

Note:

- The Robotic Cleaner does not stop operating while the Cycle Time is being set.

The Operation Time indicator is active and the Clock records the operation time.

- If Select is not pressed after setup, the Operation Time indicator is automatically activated after 60 seconds. Same logic applies to all other presets



Programming Indicators - Active set up parameters

 Select Cleaning cycle
3, 4 & 6 Hours

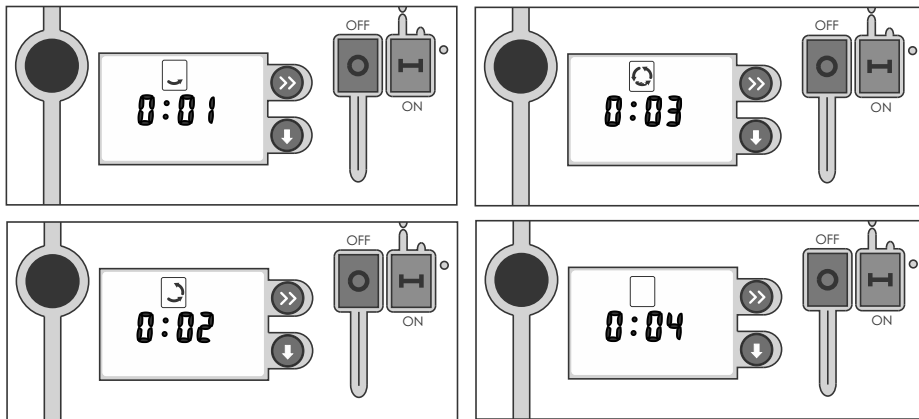

d) After programming the cleaning cycle time, the current total cleaning time appears on the power supply display. The total time is displayed until the end of the current cleaning cycle.

4. To set the delay time

Delaying Operation of the Robotic Cleaner allows:

- Debris to sink to the bottom of the pool.
- Timing the cleaning cycle to end with the opening of the pool.

The pool will be clean and ready for swimmers.

a) Press Select  until the Delay Time indicator  appears and flashes.

b) Press Set  the clock flashes 0 (no delay).

c) Press Set  until the desired Delay Time is displayed. For example, press twice to display a Delay Time of 3 hours.

d) Press Select



- the Time Display stops flashing and the Delay Time is set.
- the next programming mode appears on the display.

• the Delayed Time indicator  is activated and the clock

counts down the remaining time (if a Delay Time of 3 hours was set, cleaning is now delayed by 3 hours).

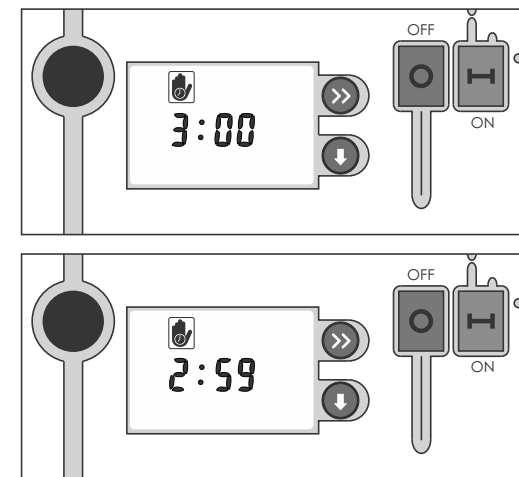

Programming Indicators - Active set up parameters

 Select Delay Time
0 (default) 3, 4 & 6

5. To select cleaning level type

RECOMMENDATION:

- Before using the Robotic Cleaner for the first time, set the Cleaning Level values according to the Cleaning Level, Pool Length and Surface Material of the pool to be cleaned.
- When using the Robotic Cleaner to clean a different pool, set the Cleaning Level values accordingly.

a) Press and hold Set ; 

and then press Select ; 

both the Cleaning Level indicator  and the Cleaning Level Display (clock) start to flash.

Programming Indicators - Active set up parameters



Select Cleaning Level Type

- Select one of three options:
- 1- Light Cleaning; short cycle
 - 2- Regular Cleaning (default); standard cycle
 - 3- Heavy Duty Cleaning; Long cycle with pump intake operating at high power

Note: Simultaneously pressing Set and Select prevents unintentional programming of the cleaning level values.

b) Press Set  until the desired Cleaning Level is displayed.

For example, press twice to display a Cleaning Level of 3.

c) Press Select  again

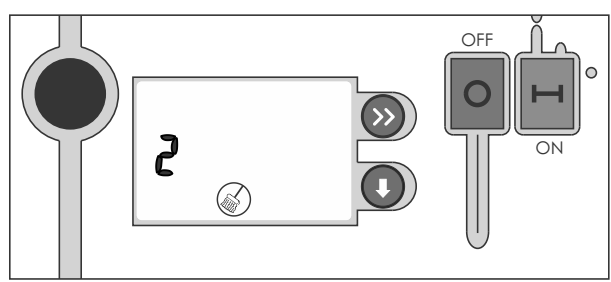

- the Cleaning Level is set.
- the next programming mode appears on the display.



6. To select pool features

RECOMMENDATION:

- Before using the Robotic Cleaner for the first time, set the Pool Feature values according to the pool to be cleaned. You can ask your dealer to set the values.
- When using the Robotic Cleaner to clean a different pool, set the Pool Feature values accordingly.

a) Press Select  until the Pool Feature indicator  appears. The Pool Features indicator start to flash.

b) Press and hold Set  and then press Select 

c) Press Set  until the desired Pool Length is displayed.

For example, press twice to display a Pool Length of 35.

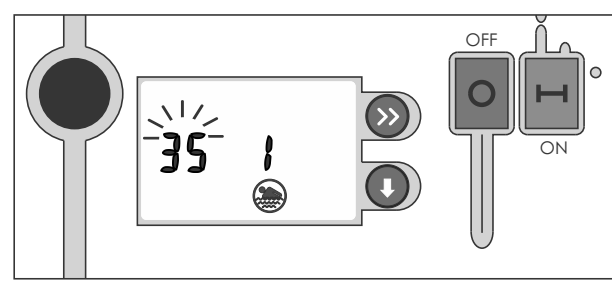

d) Press Select 

- the Pool Features indicator stops flashing and the Pool Length is set.

- the Pool Surface indicator  appears and flashes.

e) Press Set  until the desired Pool Surface is displayed.

For example, press twice to display a Pool Surface value of 2.



f) Press Select 

- the Pool Surface indicator stops flashing and the Pool Surface is set.

g) Press Select again 

- the Information Mode indicator appears on the display.

Programming Indicators - Active set up parameters



Select Pool Features

Pool Length - select one of three options:

LARGE UNITS

- 25 - Pool length is 25 meters
- 35 - Pool length is 30 to 40 meters
- 50 - Pool length is 50 meters

SMALL UNITS

- 15 - Pool length is 15 meters
- 20 - Pool length is 20 meters
- 25 - Pool length is 25 meters

Note: Pool dimensions affect the minimum cleaning time.

Pool Surface - select one of four options:

- 1- Concrete surface
- 2- Vinyl Surface
- 3- Rough ceramic surface (default)
- 4 - Smooth ceramic surface

7. Using the remote control

The Remote Control Model is provided with a radio control transmitter. This feature will enable you to directly guide the robot to any part of the pool. Pressing the Right or Left buttons causes the robot to turn until the button is released.

Pressing the Forward/Reverse button once causes the robot to stop and reverse its direction of travel.

Matching the Remote Control Unit to the Power Supply:

It is important to match the remote control transmitter to the power supply. This unique identification prevents other transmitters in the area (garage door openers, etc) from interfering with the operation of the remote control.

The original remote control provided with your robot is already matched to the power supply. If your remote control unit is not ORIGINAL, it must be matched to the power supply before it can operate.

To match the remote control unit to the power supply: Turn ON the power supply and press the menu button until the ID symbol appears. On the remote control unit, simultaneously press the left and right buttons. The ID number will appear on the power supply display. The remote control is now matched to the power supply.

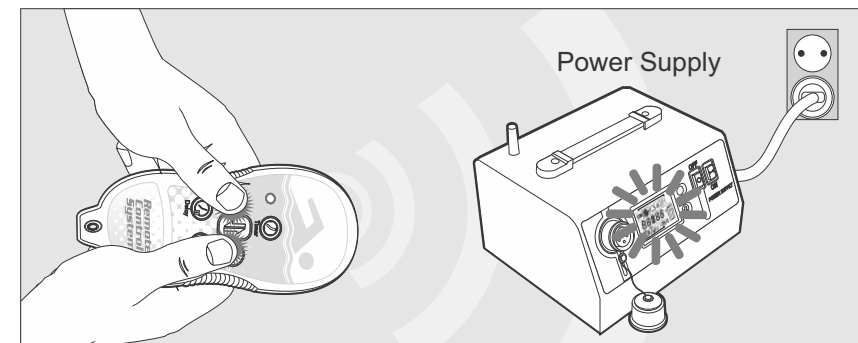

REPLACING THE BATTERY

The battery installed in the remote control can last several years. If the battery needs replacing, the red light on the remote control unit will not flash when a button is pressed.

To replace the battery:

1. Unscrew the 6 screws securing the back cover of the unit using a Philips screwdriver.
2. Remove the battery and dispose of safely.
3. Replace it with a size ½ AA 3.6V lithium battery (type 14250). Observe the correct polarity.
4. Replace the cover and secure the 6 screws. Be sure not to over tighten.

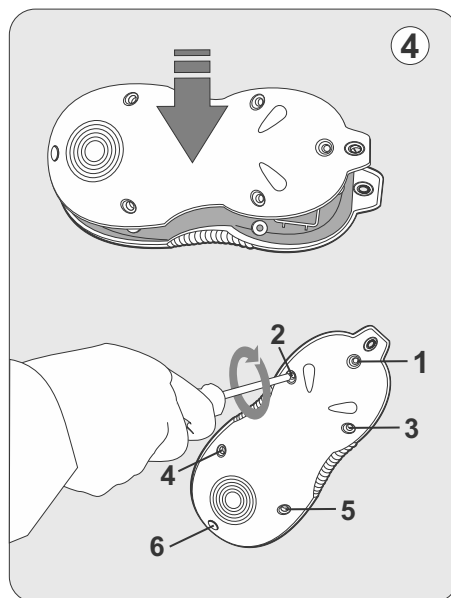
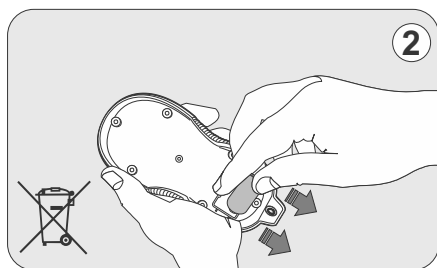
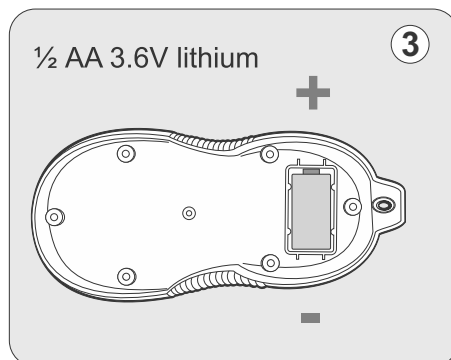
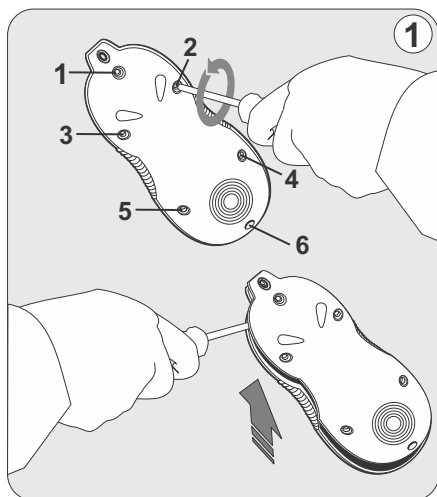

NOTE:

Dispose of the battery safely. Do not recharge, short circuit, crush, disassemble, heat above 100°C (212°F), incinerate, or expose contents to water.

Remote Control

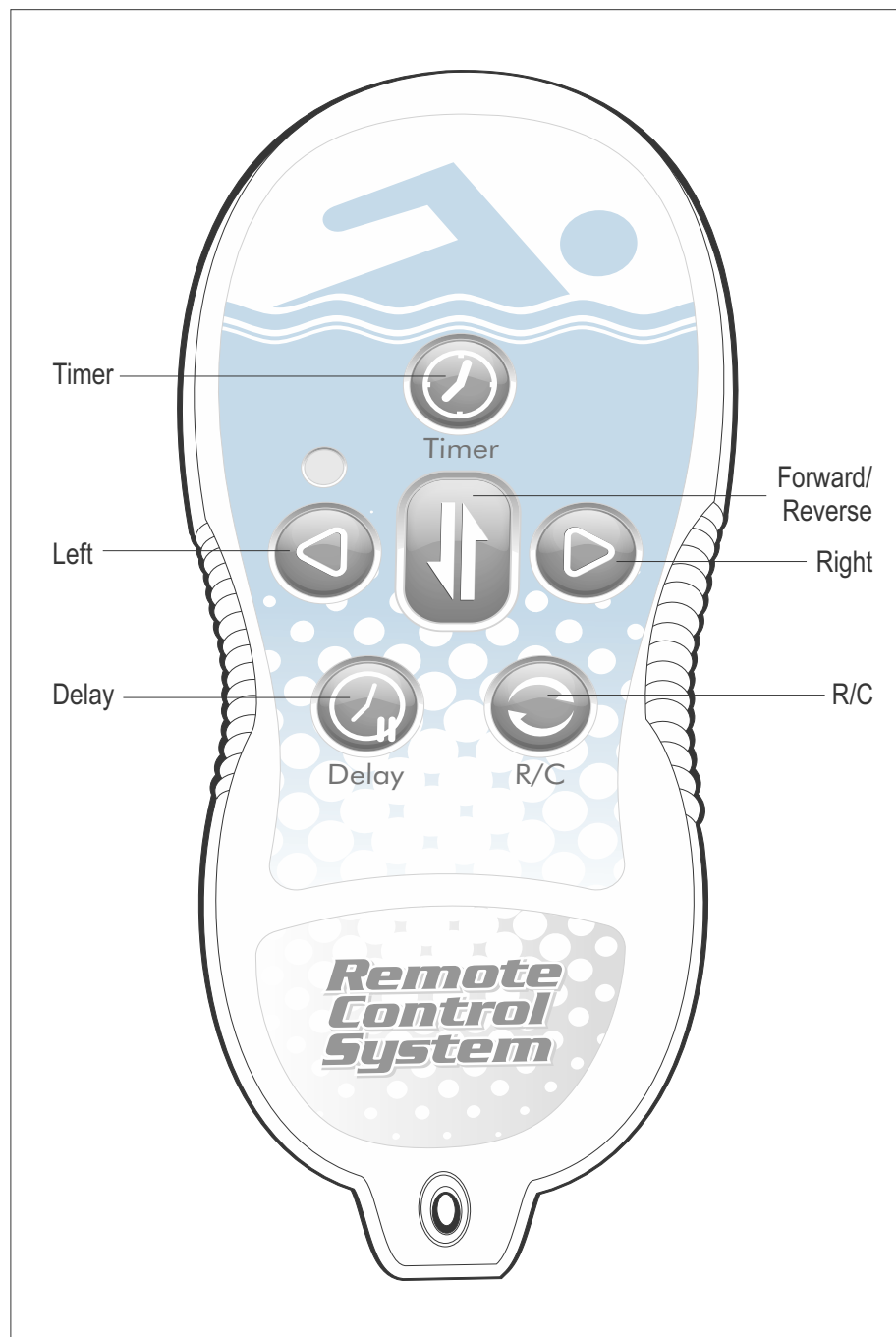

Remote Control Functions



Timer

Sets the Cycle Time.
Pressing the Timer button changes the Cycle Time on the Power Supply.
Each press of the Timer button changes the Cycle Time to the next Cycle Time option : 3, 4, 6.



Change Direction

Changes the Robotic Cleaner's current direction of motion.

- If the Robotic Cleaner is currently moving forward, pressing the Change Direction button causes the Robotic Cleaner to move backward.
- If the Robotic Cleaner is currently moving backward, pressing the Change Direction button causes the Robotic Cleaner to move forward.



Turn Left

Turns the Robotic Cleaner to the left for as long as the Turn Left button is pressed.



Turn Right

Turns the Robotic Cleaner to the right for as long as the Turn Right button is pressed.



Delay

The delay feature allows the user to postpone the beginning of a cleaning cycle. Using this feature gives time for the debris to settle down to the pool floor resulting in a more effective cleaning cycle.

- Pressing the Delay button sets the Delay Time to 2 hours.
- After the Delay Time has been set to 2, another press of the Delay button resets the Delay Time to 0 (no delay).



R/C

Changes the Robotic Cleaner's current Operating Mode: Manual Mode or Automatic Mode.



- If the Robotic Cleaner is currently in Manual Mode, pressing the R/C button changes the Robotic Cleaner to Automatic Mode.
- If the Robotic Cleaner is currently in Automatic Mode, pressing the R/C button changes the Robotic Cleaner to Manual Mode.

8. Information mode

The Information Mode provides information about:

- the last operation cycle (h)
- the total working hours of the Robotic Cleaner (H)
- any failures that occurred during the last cycle (F).
- RC ID

To view the Information Mode data



1. Press Select  until the Information Mode indicator  appears and flashes.

2. Press Set  until the desired Information option is displayed:

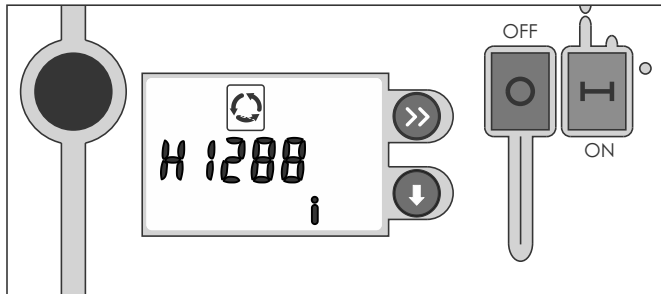
- h - the operation time of the last completed cycle, displayed in hours.
- H - the total operation time, displayed in hours format; this value also indicates the validity of the warranty.



- F - last cycle completed successfully for the last cycle operation was faulty.

3. Code  and  indicate normal operation; the cycle completed successfully.

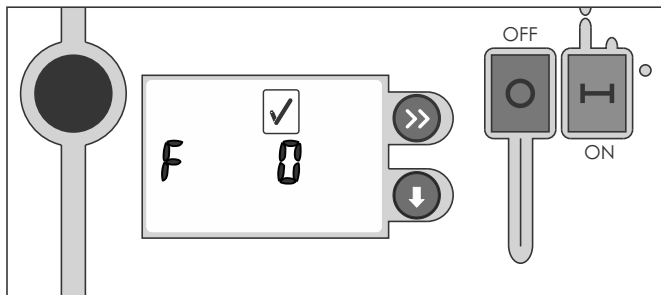

 and error code **Err** indicates faulty operation.

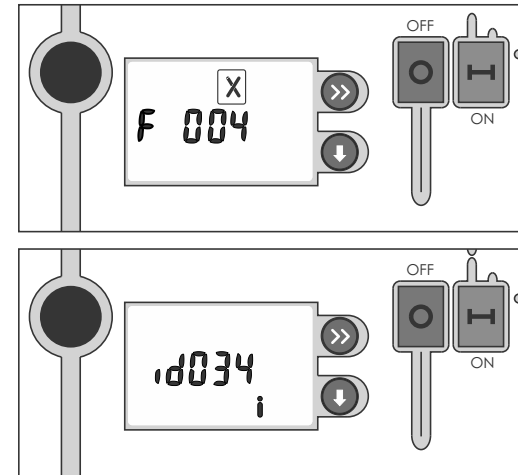

RC-id settings of the power supply and Remote control unit. New match between the power Supply and the RC has to be made according to the instruction in the RC unit only when this message is displayed

Programming Indicators - Active set up parameters

 **Information**
Displays detailed information about Robotic Cleaner operation cycles failures and RC ID:

1. Last Cycle Operation Time

Preceded by the h symbol and displayed in the hours format. This information disappears after 10 minutes into a new Cleaning Cycle.

2. Total Operation Time

The sum total of all cleaning time, starting from the first Cleaning Cycle. Preceded by the H symbol and displayed in the hours format.

3. Successful or Faulty Operation of the Previous Cycle

Normal Operation

- The Cleaning Cycle completed successfully, as indicated by the following display;

(V) - F (Fault) symbol and error code "0000".

Failure

- The cleaning cycle did not complete successfully, as indicated by the following display: (X) – F symbol and Error code number (see *Error code table*).

4. Remote Control ID

Displays the RC ID no chosen for that P.S. New ID could be programmed for a new RC unit- please refer to the programming instructions

Error Codes Table

The Error Codes will be shown on the power-supply screen, in the following format: **F XX YY**

XX digits shows an error on the power supply

YY digits shows an error in the robot

Error code for the power supply (XX)

CODE	DESCRIPTION	WHAT TO DO
01	The PS detects low power consumption, the entire robot's current is under the lowest limit	Verify that the robot is properly connected to the power-supply
08	Communication failure between the robot and power supply	Verify that the robot is properly connected to the power-supply. If not – a problem accrued in either cable or connector.
09	Low power and communication failure between the robot and power supply	Verify that the robot is properly connected to the power-supply. If not – a problem accrued in either cable or connector.
10	The PS detects high power consumption	Contact your service center
18	Communication failure between the robot and power supply and the PS detects high power consumption	Contact your service center

Error code for the robot (YY)

CODE	DESCRIPTION	WHAT TO DO
01	Master drive failure	Contact your service center
02	Master side pump failure	Check pump's connection; check if the impeller is free to rotate. Contact your service center
04	Slave drive failure	Contact your service center

Error Codes Table

The Error Codes will be shown on the power-supply screen, in the following format: **F XX YY**

XX digits shows an error on the power supply

YY digits shows an error in the robot

Error code for the robot (YY)		
CODE	DESCRIPTION	WHAT TO DO
08	Slave side pump failure	Check pump's connection; check if the impeller is free to rotate. Contact your service center
10	Collection bags are full	Clean the collection bags
20	Beach Boy / Low pumps power consumption has been detected	If occurs when the robot is in water the problem can be in the master pump or master drive. Contact your service center
40	Communication failure, between master and slave drives	Usually caused due to bad wiring, water in connectors and some time due to hardware problem in master or slave drives
03	Master drive and master side pump failed	Contact your service center
05	Both motor drives failed	Contact your service center
0A	High power consumption due to master and slave pumps	Contact your service center
0C	Slave drive and slave side pump failed	Contact your service center
12	Collection bags are full and Master side pump failure	Clean the Filter bags and if doesn't help, Check pump's connection, check if the impeller is free to rotate. Contact your service center
13	Collection bags are full, master drive and master side pump failed	Contact your service center
18	Collection bags are full and Slave side pump failure	Clean the Filter bags and if doesn't help, Check pump's connection, check if the impeller is free to rotate. Contact your service center

Error Codes Table

Error code for the robot (YY) cont.

CODE	DESCRIPTION	WHAT TO DO
1A	Collection bags are full and high power consumption due to master and slave pumps	Clean the Filter bags and if doesn't help, Check pump's connection, check if the impeller is free to rotate. Contact your service center
1C	Collection bags are full, slave drive and slave side pump failed	Contact your service center
24	Beach Boy / Low pumps power consumption has been detected	If occurs when the robot is in water, the problem can be in the master pump or master drive. Contact your service center
47	Communication between master and slave drives, master drive and master side pump failed	Contact your service center
44	Communication between master and slave drives and slave drive failure	Contact your service center
57	Communication between master and slave drives, master drive and master side pump failed. Collection bags are full	Contact your service center

Bag Full Mode

When the Filter Bag is full, the Bag Full indicator automatically lights up. When the Bag Full indicator is activated, it is highly recommended to empty and wash the Filter Bag. A full Filter Bag will impede the cleaning operation and might cause the Robotic Cleaner to stop due to pump overload.



Full Bag indicator

Indicates that Filter Bag is full. Empty the Filter Bag and wash it.

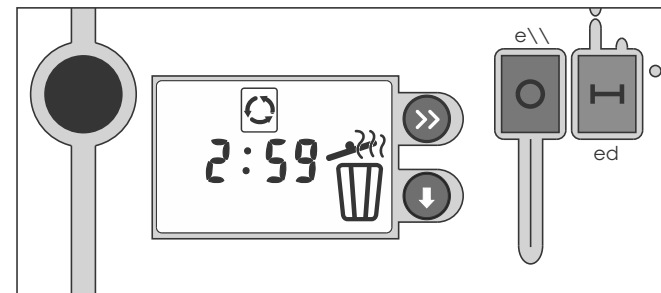

9. Maintenance and adjustment

CLEAN THE FILTER BAG AFTER EVERY CLEANING CYCLE

- a. CAUTION:** Unplug the power supply. (Please keep the plug away from contact with water)
- b.** If the unit is in the pool, gently pull the cleaner toward you using the cable until the handle is within reach. Use the handle (not the cable) to pull the cleaner out of the pool after allowing most of the water to drain from the unit.
- c.** Lay the unit on its back on a smooth surface (in order to prevent scratches on the machine body), release the lock tabs and remove the bottom lid assembly. (fig. a, b, c, d)
- d.** Remove the filter bag from the support bars, turn it inside out and wash off all the dirt with a garden hose or in a sink. Squeeze the bag gently until the rinse water is clear. If necessary, machine wash the bag using only cold water with NO DETERGENT!
- e.** Re-install the bag on the support bars with the **label** in the center of one of the long sides of the bottom lid (d)
- f.** Re-install the bottom lid assembly in the body. Push down on it until lock tabs will snap into place properly.

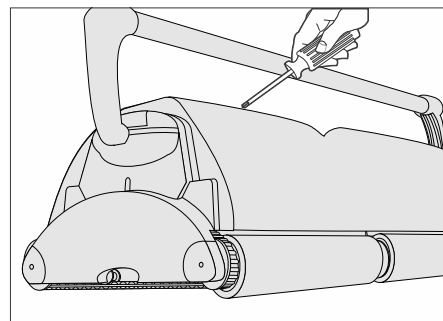
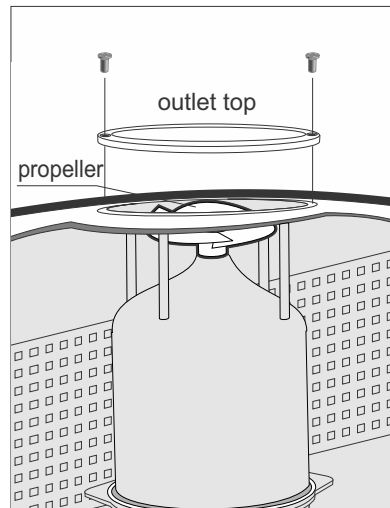
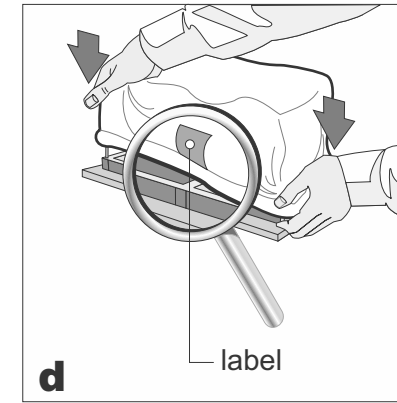
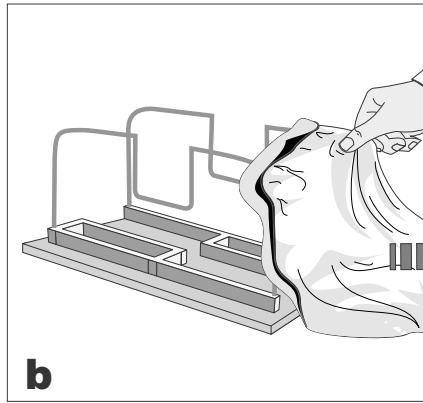
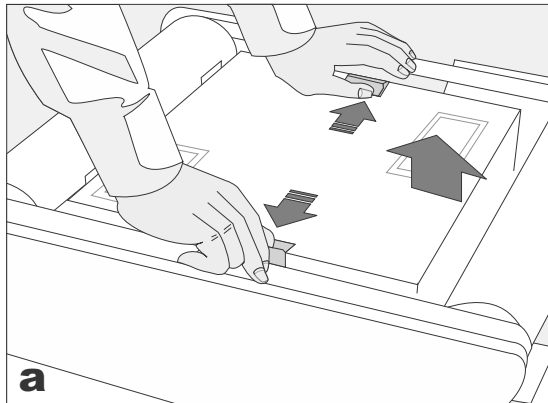

- Cleaning the pump propeller:**
- 1) Take out the 2 (4) screws from the outlet top
 - 2) Take out the outlet top and remove hair and other debris around propeller

CAUTION:

To avoid scratches and other blemishes appearing on your robot, simply find a smooth surface for it to rest on when cleaning the debris bag or performing minor adjustments. These scratches could produce changes in the robots soft and smooth edges resulting in potential damage to some flexible pool surfaces.

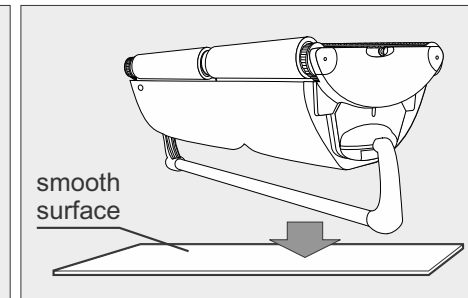
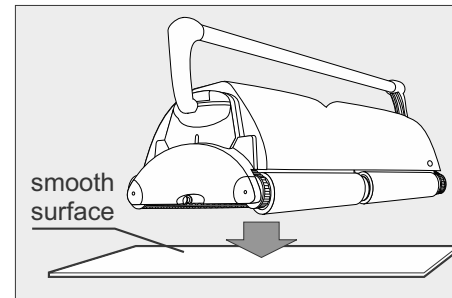

10. Troubleshooting Guide

PLEASE CHECK THE FOLLOWING BEFORE CALLING YOUR SERVICE CENTER

Before troubleshooting, the pool cleaner must be disconnected from the power supply and the power supply must be unplugged from the electrical outlet to prevent damage to the unit and possible personal injury.

For reference numbers, consult the parts list diagram located on the first page of the instructions.

Problems	Things to check
<p>1. Unit does not pump water or move:</p>	<ul style="list-style-type: none"> a) Check to see if electric outlet has power. b) Check if transformer is plugged into a grounded outlet and the blue cable assembly (27) is plugged into the transformer.* c) Switch the power supply "OFF" and "ON" a few times. Allow 45 seconds between "ON" and "OFF". d) Check for and remove any debris such as hair, string, or leaves that may be obstructing the free movement of the Drive Tracks (4). e) Check that the Drive Tracks (4) are properly aligned and are tight. Adjust or replace if necessary.
<p>2. Unit does not pump water at all, or pumps slowly but moves:</p>	<ul style="list-style-type: none"> a) Check to see if propeller is seized due to accumulation of hair or debris. Remove the top screws on each outlet top and clean the propeller. When reassembling the top cover, do not overtighten the screws. (For details see "Maintenance and adjustment" chapter of this guide) b) Check to see if the filter bag (31) is thoroughly clean. Clean as necessary. c) If a and b are negative, check the pump motors. If they are not functioning send the unit to your service center.

*The transformer cord can only be replaced with the aid of special purpose tools normally available only to authorized dealers, distributors and service centers.

Troubleshooting Guide

Problems	Things to check
<p>3. Unit does not move but does pump water:</p>	<ul style="list-style-type: none"> a) Check to see if forward/reverse motion is obstructed by foreign matter; hair, debris, etc. on drive tracks or there is an entanglement with the power cord. Clean as necessary. b) Check if drive tracks (4) have slipped out of place. Also check for proper tension of drive tracks (4). If necessary replace them. c) Check for loose drive motor connections. d) If a, b, and c are negative, check the Master and Slave motors. If one or the other is not functioning, send the unit to your service center.
<p>4. Unit does not pick up dirt and debris:</p>	<ul style="list-style-type: none"> a) Check 2a and 2b of this guide. b) Check the Intake Valve Flaps (32) on the bottom lid (30) of your unit. The Flaps should move freely to open and close. Clean and free the Valve Flaps (32) if necessary.
<p>5. Unit does not seem to cover the entire pool:</p>	<ul style="list-style-type: none"> a) Most likely a thorough cleaning of the filter bag (31) is needed. b) Check to see that the blue cable (27) is properly spread out and is untangled. c) Allow the unit to run in the pool for the entire cleaning cycle. d) Make sure that the Floating Handle (2) is locked diagonally across the top of your unit's body. e) Check that the Pump Motor is operating. Please refer to the Troubleshooting section titled <i>"Moves But Does Not Pick Up Dirt And Debris"</i> f) After following all of the above, if there is still a problem, call your dealer for specific additional assistance.

Troubleshooting Guide

Problems	Things to check
<p>6. Remote control does not operate properly:</p>	<p>a) Check the battery in the Remote Control Transmitter (14), replace if necessary. b) Make sure that you activate the RC System (14) no more than 30 meters away from the Transformer, pointing the remote control toward it. c) If there is still a problem with the RC System, call your service center for assistance.</p>
<p>7. Debris Comes Out Of The Unit When Removing It From Pool (Bottom Lid Does Not Close Properly)</p>	<p>a) Lock Tabs - Check that the Lock Tabs are not deformed. They should be straight and aligned with the unit's body. b) Intake Valves - Check that the Intake Valve Flaps (32) on the underside of your unit (in the Bottom Lid (30)) move freely to open and close. Clean Flaps (32) if necessary.</p>
<p>8. The cable is twisted:</p>	<p>a) Reverse the diagonal position of the handle (2). b) Use the E-Z swivel (29) as shown bellow.</p>

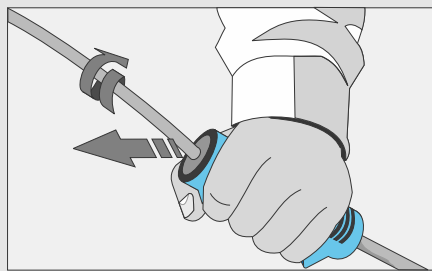
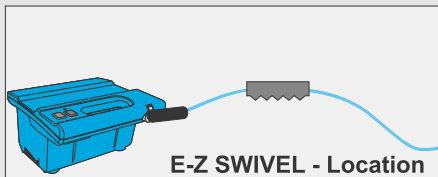

Holding with one hand the E-Z Swivel.

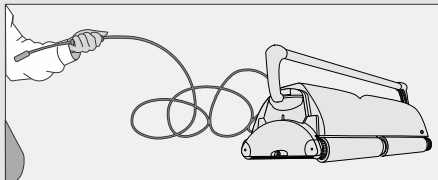

Place the robot on the ground and unplug the cable from the transformer. With one hand, holding the E-Z Swivel, walk away from the Robot, pulling the cable to its full length.

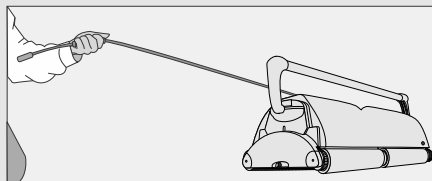

The core will rotate inside the cover and in this way will untangle the cable.

CABLE CARE

The cable may become twisted after a period of time in use. To correct this condition, simply lock the moveable handle on the top of the cleaner in the opposite diagonal direction. The pool cleaner will now travel in the opposite direction while cleaning your pool and the cable will uncoil. Check the cable periodically for external damage. If the problem persists, use the E-Z Swivel device.

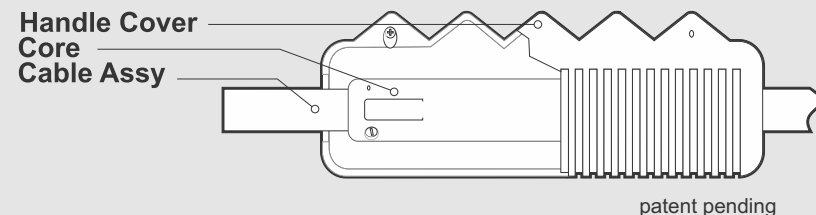

patent pending

Troubleshooting Guide

Problems	Things to check
<p>9. When you turn “ON” the robot, the pumps run for about 6 seconds and it shoots “OFF”. After 45 seconds, the power supply shoots 'OFF”.</p>	<p>Program the power supply to use STAND BY  period of 0 hours and restart the system. You can also cancel the STAND BY mode and transit to operation mode just by pressing the DELAY button on the RC.</p>





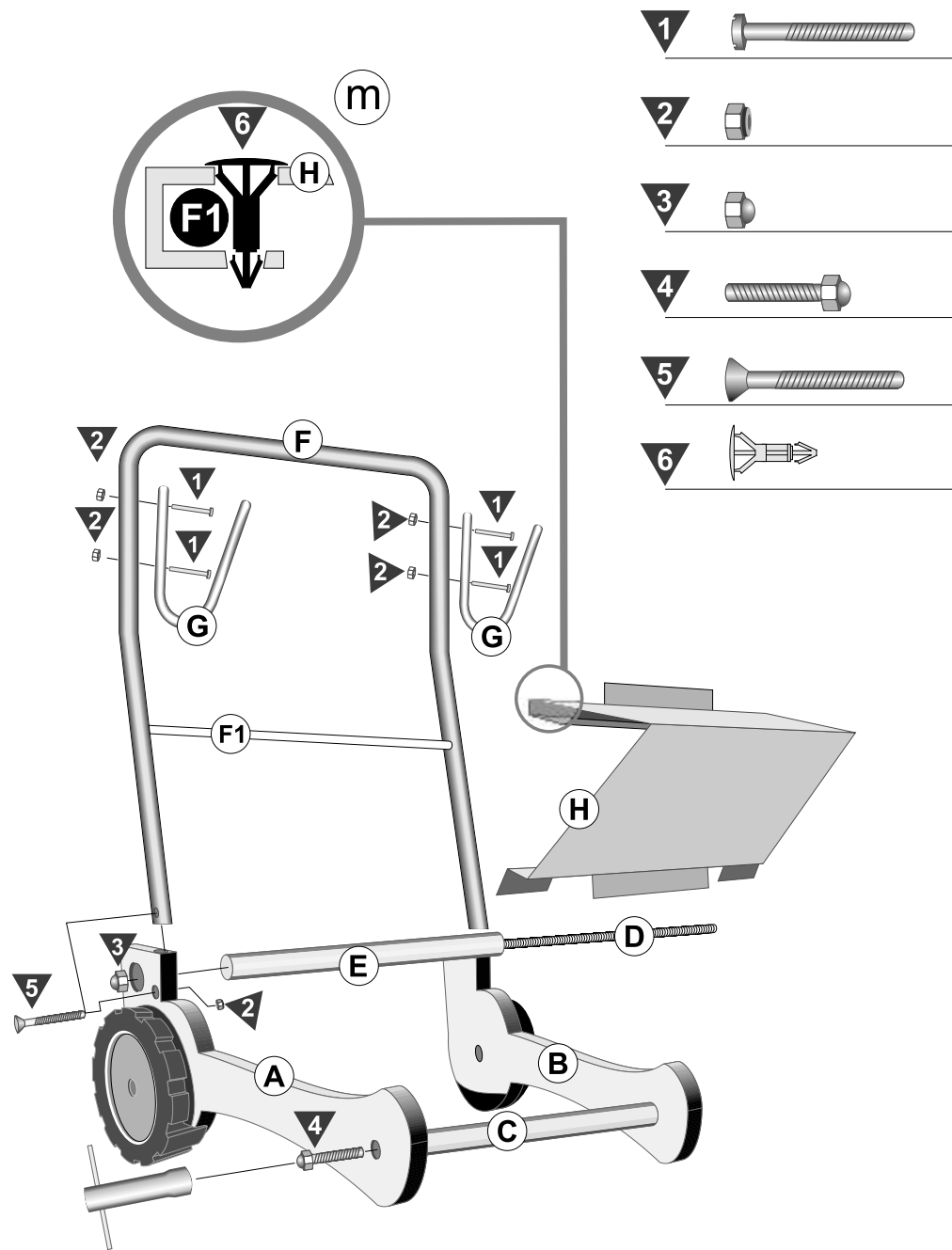

IMPORTANT:

Please be sure to always keep your pool cleaner properly stored anywhere between 10 to 40 degrees Celsius (50 to 104 degrees Fahrenheit). This will keep the motors, plastics and seals protected. Failure to comply will result in loss of warranty.

Robot can be used in water with temperatures ranging from 13°C to 35°C (55°F to 95°F). However, the recommended optimal temperature is between 22°C and 32°C (72°F and 90°F)

11. Aqua Kart FOR LARGE COMMERCIAL - PUBLIC POOL CLEANERS





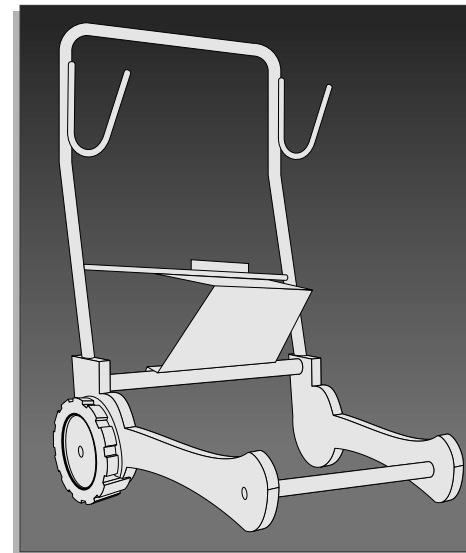

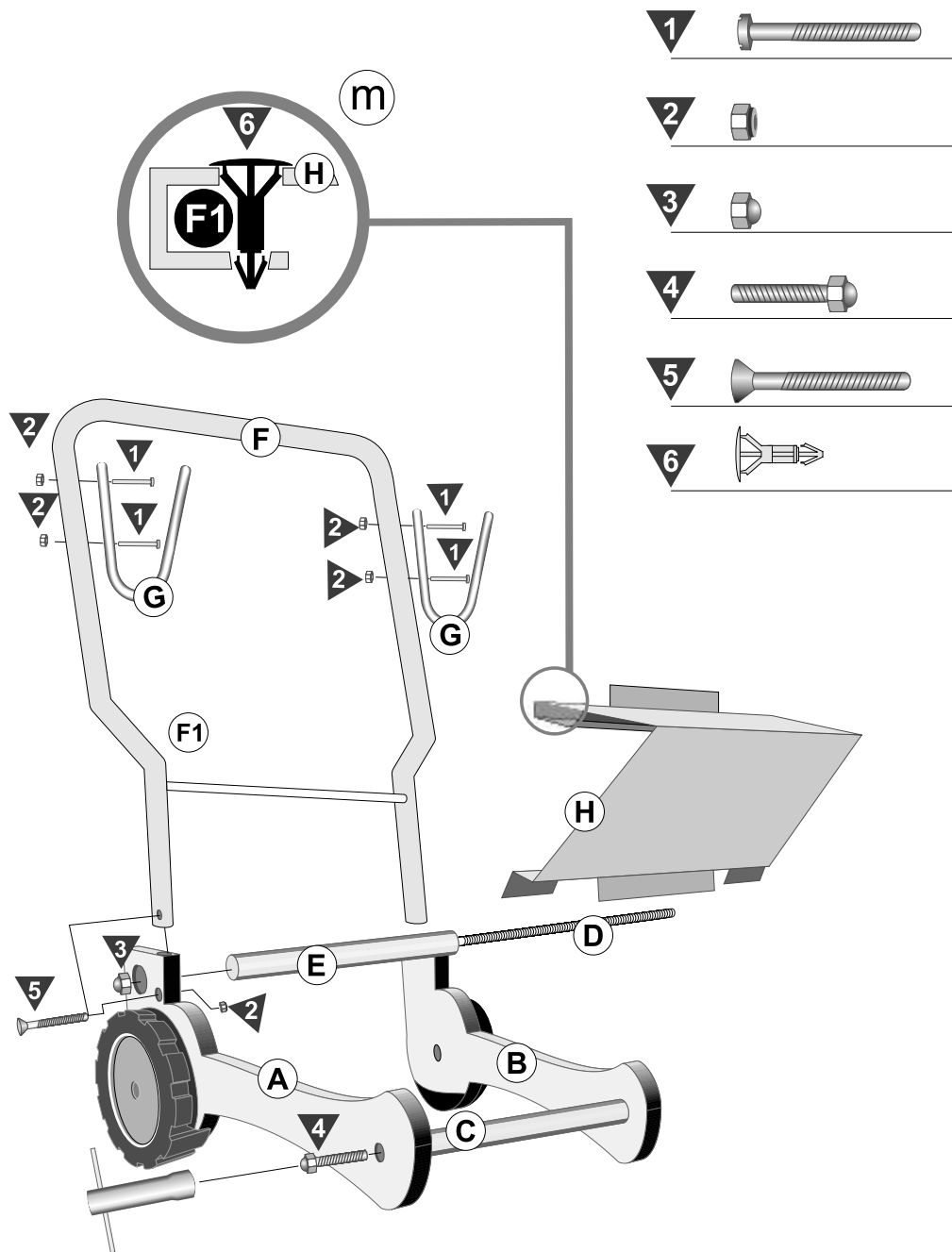

- 1** 
 - 2** 
 - 3** 
 - 4** 
 - 5** 
 - 6** 
- (A)** Left Plate
All connection steps for part A are the same for part B
 - (B)** Right Plate
 - (C)** Weighted Front Rod
Connect part A and B of front with screw #4
 - (D)** Thread Rod
Fits inside part E
 - (E)** Back Rod
Connects A and B in the rear of assembly with nut #3
 - (F)** Handle
Connects to A and B in the rear at bottom part with screw #5 and nut #2
 - (G)** Cable Holders
Connect to F by utilizing screw #1 and nut #2
 - (H)** Power Supply Shelf
Connects to rod F by pressing lightly. It then leans on rod E and is secured by two plastic pins #6. See detail M



11. Aqua Kart FOR SMALL COMMERCIAL - PUBLIC POOL CLEANERS



- 1** 
 - 2** 
 - 3** 
 - 4** 
 - 5** 
 - 6** 
- (A)** Left Plate
All connection steps for part A are the same for part B
 - (B)** Right Plate
 - (C)** Weighted Front Rod
Connect part A and B of front with screw #4
 - (D)** Thread Rod
Fits inside part E
 - (E)** Back Rod
Connects A and B in the rear of assembly with nut #3
 - (F)** Handle
Connects to A and B in the rear at bottom part with screw #5 and nut #2
 - (G)** Cable Holders
Connect to F by utilizing screw #1 and nut #2
 - (H)** Power Supply Shelf
Connects to rod F by pressing lightly. It then leans on rod E and is secured by two plastic pins #6. See detail M

