

# Pool Surrounding Equipment

DURABLE FOR ALL WEATHER CONDITIONS

Resistant to pool chemical and sunlight



Material

Reinforced ABS for strength  
and longevity of use

 **Emaux**  
water technology

**Pool & Spa Equipment**

[www.emauxgroup.com](http://www.emauxgroup.com)

# Outlet Fittings Heavy Duty Skimmer

## Corrosion-Proof Unibody Construction

The heavy-duty skimmer can be used for residential and commercial swimming pools suitable for concrete, fiberglass and vinyl surfaces. The 3 models are injection molded and made with UV resistant ABS material; the reinforced material provides the maximum strength and durability for all weather conditions. The high flexibility design allows 1.5" or 2" suction connections to the piping.

### Product Features

1. Suitable for 1.5" and 2" piping
2. Knockout overflow / fill port
3. Large debris collection basket
4. Snap-in and removable weir
5. Optional accessories:
  - a) stackable extension collar allows infinite vertical height
  - b) stackable extension throat allows infinite horizontal length

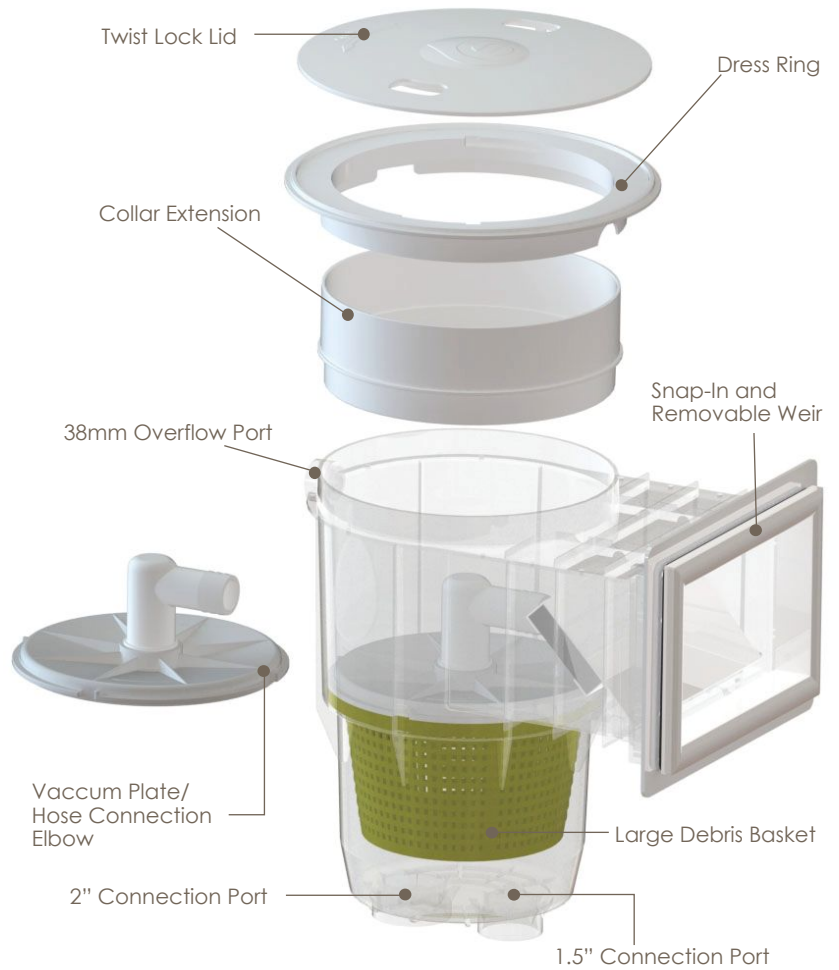

## Standard Wall Heavy Duty Skimmer

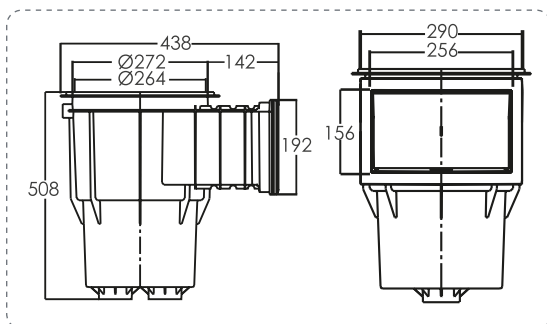

EM0030RV EM0030RC



EM0030SV EM0030SC

Code	Model	Material	Application
88150912	EM0030-RV	ABS	Vinyl Pool (Round Cover)
88151012	EM0030-RC	ABS	Concrete Pool (Round Cover)
88151112	EM0030-SV	ABS	Vinyl Pool (Square Cover)
88151212	EM0030-SC	ABS	Concrete Pool (Square Cover)

## Wide Mouth Wall Heavy Duty Skimmer

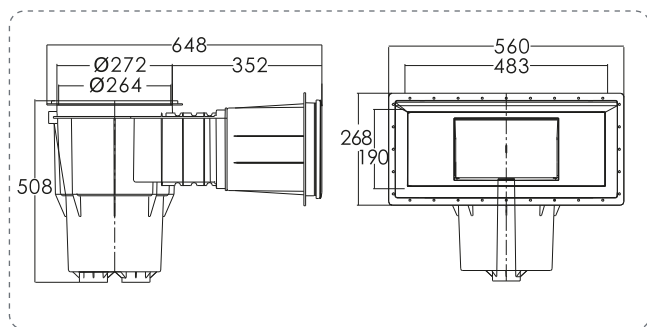

EM0040RV EM0040RC

EM0040SV EM0040SC

Code	Model	Material	Application
88151312	EM0040-RV	ABS	Vinyl Pool (Round Cover)
88151412	EM0040-RC	ABS	Concrete Pool (Round Cover)
88151512	EM0040-SV	ABS	Vinyl Pool (Square Cover)
88151612	EM0040-SC	ABS	Concrete Pool (Square Cover)

## Heavy Duty Skimmer With Extension

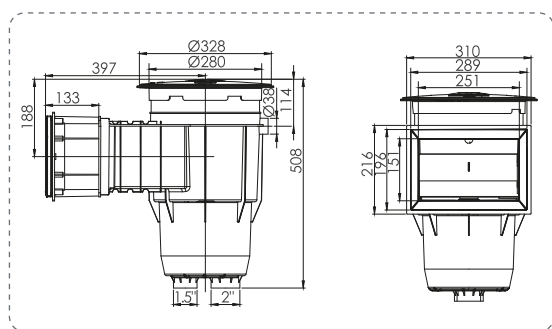

EM0050RV EM0050RC

EM0050SV EM0050SC

Code	Model	Material	Application
88151712	EM0050-RV	ABS	Vinyl Pool (Round Cover)
88151812	EM0050-RC	ABS	Concrete Pool (Round Cover)
88151912	EM0050-SV	ABS	Vinyl Pool (Square Cover)
88152012	EM0050-SC	ABS	Concrete Pool (Square Cover)

## Heavy Duty Skimmer Accessories



**Wide Mouth Extension**  
Code: 01051183



**Extension Throat**  
(wide) Code: 01050023  
(narrow) Code: 01050032



**Extension Collar**  
Code: 01050004



**Basket with Plastic Handle**  
Code: 89150501



**Square Dress Ring**  
Code: 01211036



**Round Dress Ring**  
Code: 01211035



**Skimmer Cover**  
Code: 01211034



**Vacuum Plate**  
Code: 01051180



**90° Vacuum Hose Connector**  
Code: 01050007

# Outlet Fittings **Skimmer**

## 9.5L Wall Skimmer EM0010

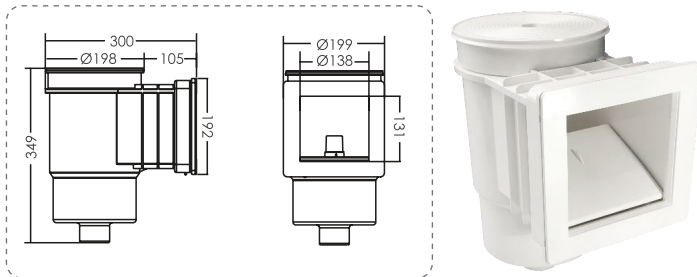

Code	Model	Connection	Application	Flow Rate (L/min)
91600302	EM0010-RV	1.5" Internal Threaded	Vinyl Pool	150
91600301	EM0010-RC	1.5" Internal Threaded	Concrete Pool	150

## 9.5L Wide Mouth Wall Skimmer EM0020

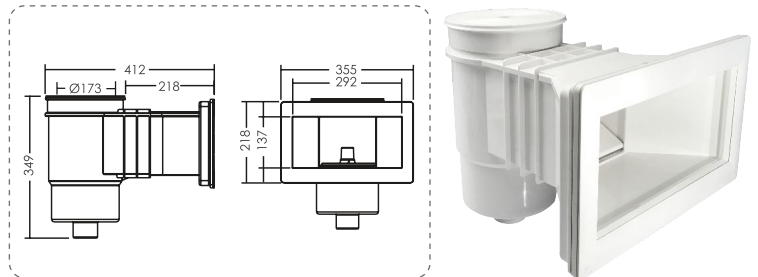

Code	Model	Connection	Application	Flow Rate (L/min)
91601002	EM0020-RV	1.5" Internal Threaded	Vinyl Pool	150
91601001	EM0020-RC	1.5" Internal Threaded	Concrete Pool	150

## 15L Standard Wall Skimmer EM0130

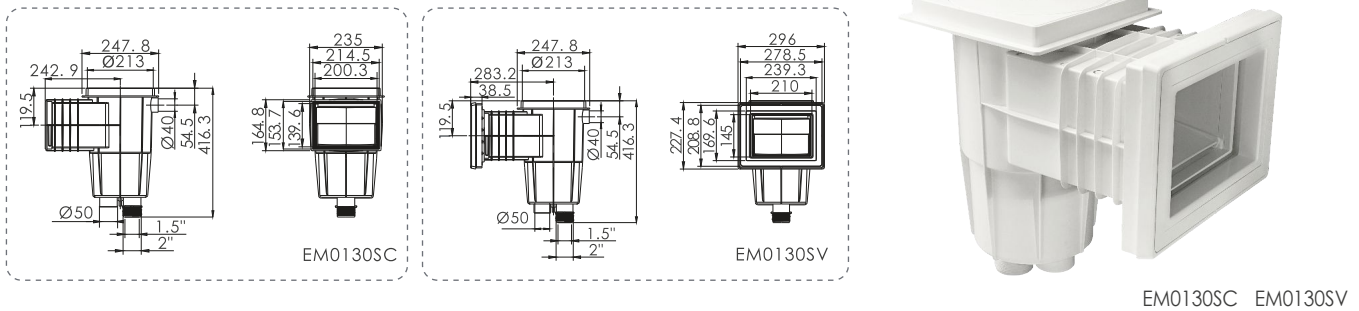

EM0130SC EM0130SV

Code	Model	Connection	Application	Flow Rate (L/min)
91600315	EM0130-SC	1.5" and 2" Internal Threaded and 1.5" Solvent Internal	Concrete Pool	150 - 200
91600316	EM0130-SV	1.5" and 2" Internal Threaded and 1.5" Solvent Internal	Vinyl Pool	150 - 200
91600320	EM0130TS-SV	1.5" and 2" Internal Threaded and 1.5" Solvent Internal	Vinyl Pool (without brass inserts)	150 - 200

## 15L Wide Mouth Wall Skimmer EM0140

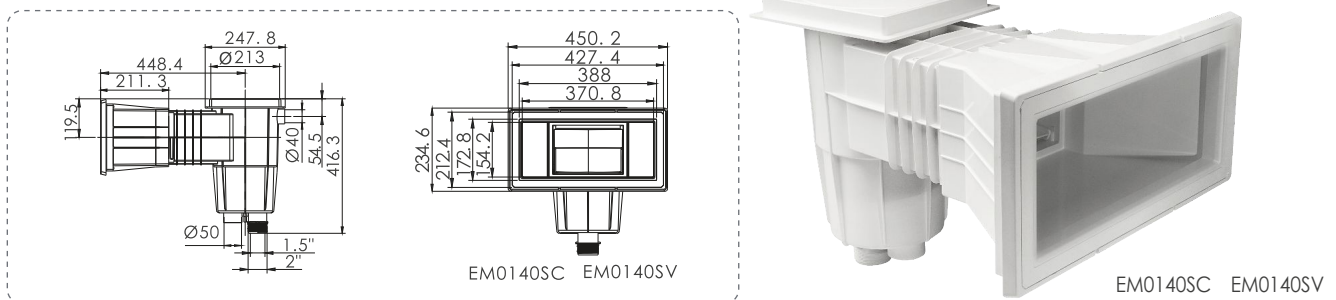

EM0140SC EM0140SV

Code	Model	Connection	Application	Flow Rate (L/min)
91601013	EM0140-SC	1.5" and 2" Internal Threaded and 1.5" Solvent Internal	Concrete Pool	150 - 200
91601014	EM0140-SV	1.5" and 2" Internal Threaded and 1.5" Solvent Internal	Vinyl Pool	150 - 200
91601016	EM0140TS-SC	1.5" and 2" Internal Threaded and 1.5" Solvent Internal	Concrete Pool (without brass inserts)	150 - 200
91601017	EM0140TS-SV	1.5" and 2" Internal Threaded and 1.5" Solvent Internal	Vinyl Pool (without brass inserts)	150 - 200

# Outlet Fittings VGB Anti-Vortex Main Drain

## Anti-Vortex Main Drain

This series of Main Drains comply with provisions of ANSI/APSP-16 2011 standard and the Virginia Graeme Baker Pool and Spa Safety Act. High quality main drains are made of ABS which has the resistance in pool chemical and sunlight.



### Main Drain EM2813

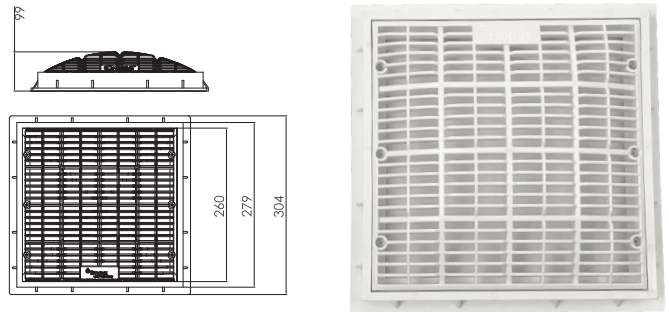

Code	Model	Size	Flow Rate (L/min)
91600509	EM2813	260 x 260mm	900

### Main Drain EM2816 (with AISI 316 Frame)

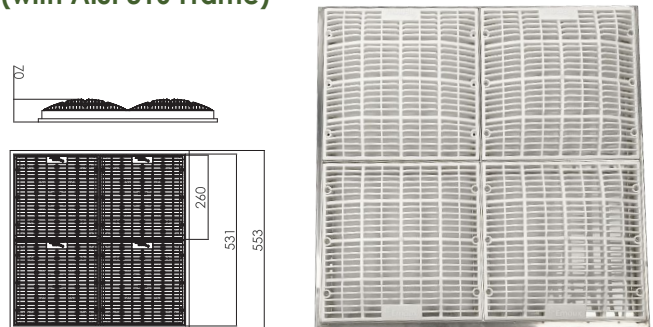

Code	Model	Size	Flow Rate (L/min)
91600510	EM2816	531 x 531mm	3600

### Main Drain EM2815

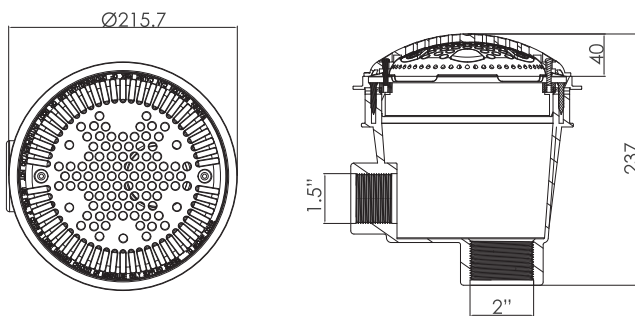

Code	Model	Connection	Application	Flow Rate (L/min)
91600511	EM2815C	1.5" / 2" Internal Threaded	Concrete Pool	240
91600512	EM2815V	1.5" / 2" Internal Threaded	Vinyl Pool	240

# Outlet Fittings Main Drain



## 2" Main Drain

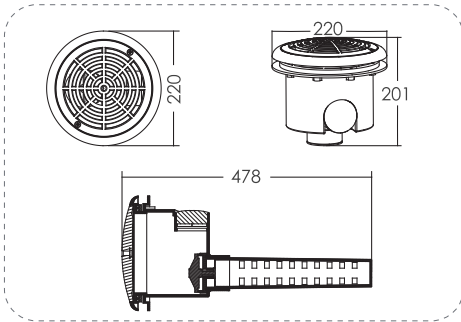

EM2833C/EM2833V



89140501



01051155



EM2833HC

Code	Model	Connection	Description	Flow Rate (L/min)
91600504	EM2833HC	2" Internal Threaded	For Concrete Pool with Hydrostatic Relief Valve & Collection Tube	240
91600505	EM2833HV	2" Internal Threaded	For Vinyl Pool with Hydrostatic Relief Valve & Collection Tube	240
91600503	EM2833C	2" Internal Threaded	For Concrete Pool	240
91600506	EM2833V	2" Internal Threaded	For Vinyl Pool	240
89140501	--	--	Hydrostatic Relief Valve	N/A
01051155	--	--	Hydrostatic Relief Valve Collection Tube Only	N/A

## 1.5" Main Drain

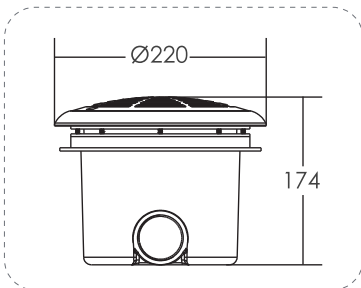

## Gutter Drain

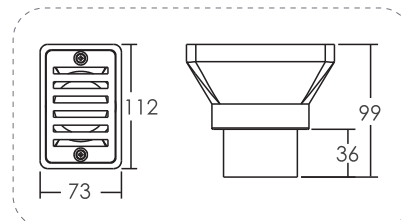

Code	Model	Connection	Application	Flow Rate (L/min)
91600507	EM2832C	1.5" Internal Threaded	Concrete Pool	150
91600508	EM2832V	1.5" Internal Threaded	Vinyl Pool	150

Code	Model	Connection	Measure	Flow Rate (L/min)
91600801	EM2819(A1)	1.25" Solvent	Imperial	92
91600802	EM2819(A2)	1.5" Solvent	Imperial	150
91600803	EM2819(A3)	2" Solvent	Imperial	240
91600804	EM2819(E1)	50mm Solvent	Metric	150
91600805	EM2819(E2)	63mm Solvent	Metric	240

## Round Drain Cover

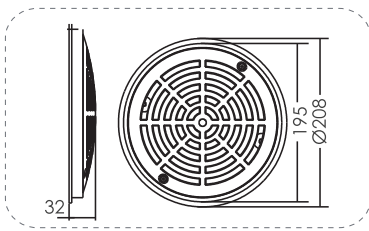

## Square Drain Cover

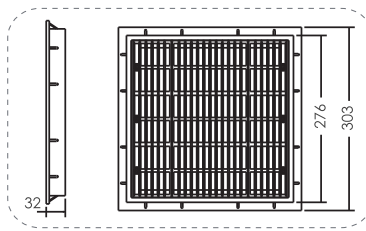

Code	Model	Size	Flow Rate (L/min)
91600502	EM2830	195mm Diameters	558

Code	Model	Size	Flow Rate (L/min)
91600501	EM2812	276 x 276 mm	850

## Main Drain EM2837



## Main Drain EM2838

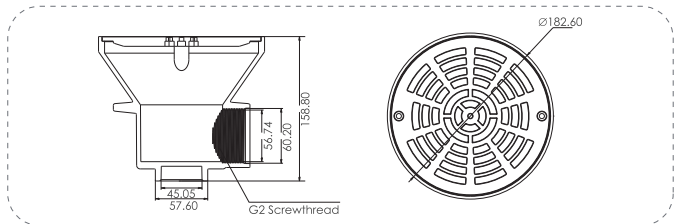
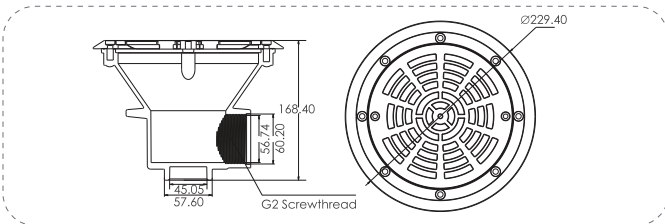

Code	Model	Connection	Application	Flow Rate (L/min)
91600514	EM2837	G2A Internal Threaded	Vinyl and Liner Pool	217
91600523	EM2837 TS	G2A Internal Threaded	Vinyl and Liner Pool (without brass inserts)	217

Code	Model	Connection	Application	Flow Rate (L/min)
91600515	EM2838	G2A Internal Threaded	Concrete Pool	217

## Main Drain EM2839



## Main Drain EM2840

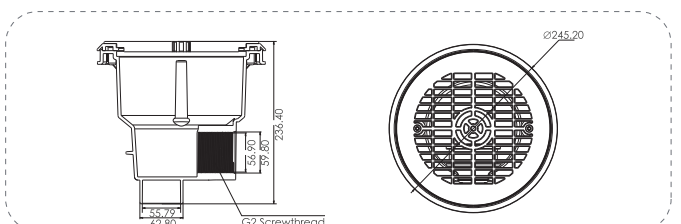
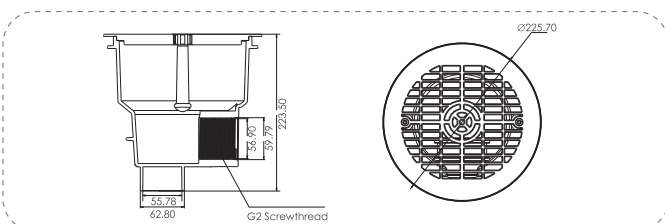

Code	Model	Connection	Application	Flow Rate (L/min)
91600516	EM2839	G2A Internal Threaded	Concrete Pool	217

Code	Model	Connection	Application	Flow Rate (L/min)
91600517	EM2840	G2A Internal Threaded	Vinyl Pool	217

# Outlet Fittings

## SUCTION AND VACUUM

### Suction Fitting

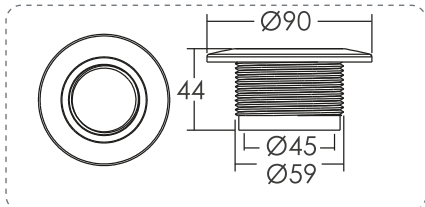

Code	Model	Flow Rate (L/min)
91601501	EM2822	150

91601501 EM2822 150

### Cover of Suction Fittings

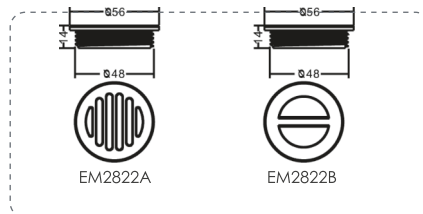

Code	Model	Flow Rate (L/min)
91601502	EM2822A	115
91601503	EM2822B	115

91601502 EM2822A 115  
91601503 EM2822B 115

### Vacuum Fitting (Concrete Pool)

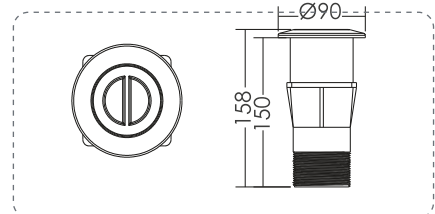

Code	Model	Connection	Measure	Flow Rate (L/min)
91601504	EM2827C(A)	1.5"	Imperial	150
91601506	EM2827C(E)	50mm	Metric	150

91601504 EM2827C(A) 1.5" Imperial 150  
91601506 EM2827C(E) 50mm Metric 150

### Vacuum Fitting (Vinyl Pool)

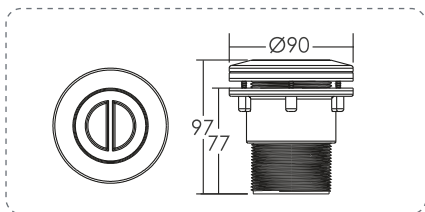

Code	Model	Connection	Measure	Flow Rate (L/min)
91601505	EM2827V(A)	1.5"	Imperial	150
91601507	EM2827V(E)	50mm	Metric	150

91601505 EM2827V(A) 1.5" Imperial 150  
91601507 EM2827V(E) 50mm Metric 150

### Outlet Fitting (Concrete Pool)

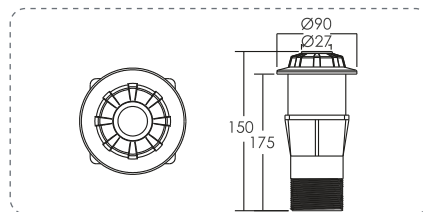

Code	Model	Connection	Measure	Flow Rate (L/min)
91601201	EM2828C(A)	1.5"	Imperial	69
91601203	EM2828C(E)	50mm	Metric	69

91601201 EM2828C(A) 1.5" Imperial 69  
91601203 EM2828C(E) 50mm Metric 69

### Outlet Fitting (Vinyl Pool)

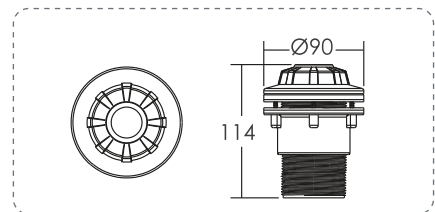

Code	Model	Connection	Measure	Flow Rate (L/min)
91601202	EM2828V(A)	1.5"	Imperial	69
91601204	EM2828V(E)	50mm	Metric	69

91601202 EM2828V(A) 1.5" Imperial 69  
91601204 EM2828V(E) 50mm Metric 69

### Vacuum EM2831

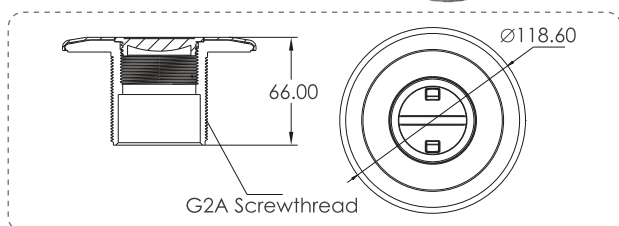

Code	Model	Connection	Measure	Flow Rate (L/min)
91601508	EM2831(A)	1.5" Solvent, G2A Screwthread	Imperial	150-240
91601509	EM2831(E)	50mm Solvent, G2A Screwthread	Metric	150-240

91601508 EM2831(A) 1.5" Solvent, G2A Screwthread Imperial 150-240  
91601509 EM2831(E) 50mm Solvent, G2A Screwthread Metric 150-240

### Vacuum EM2836

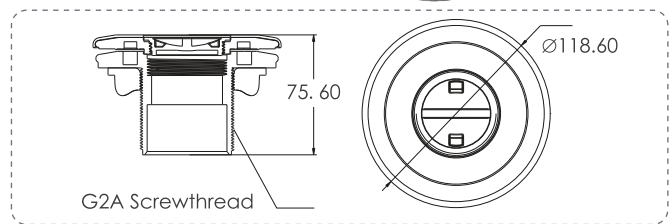

Code	Model	Connection	Measure	Brass Inserts	Flow Rate (L/min)
91601510	EM2836A	1.5" Solvent, G2A Screwthread	Imperial	Yes	150-240
91601511	EM2836E	50mm Solvent, G2A Screwthread	Metric	Yes	150-240
91601516	EM2836A TS	1.5" Solvent, G2A Screwthread	Imperial	No	150-240
91601517	EM2836E TS	50mm Solvent, G2A Screwthread	Metric	No	150-240

91601510 EM2836A 1.5" Solvent, G2A Screwthread Imperial Yes 150-240  
91601511 EM2836E 50mm Solvent, G2A Screwthread Metric Yes 150-240  
91601516 EM2836A TS 1.5" Solvent, G2A Screwthread Imperial No 150-240  
91601517 EM2836E TS 50mm Solvent, G2A Screwthread Metric No 150-240



# Other Fittings

## Water Level Regulator

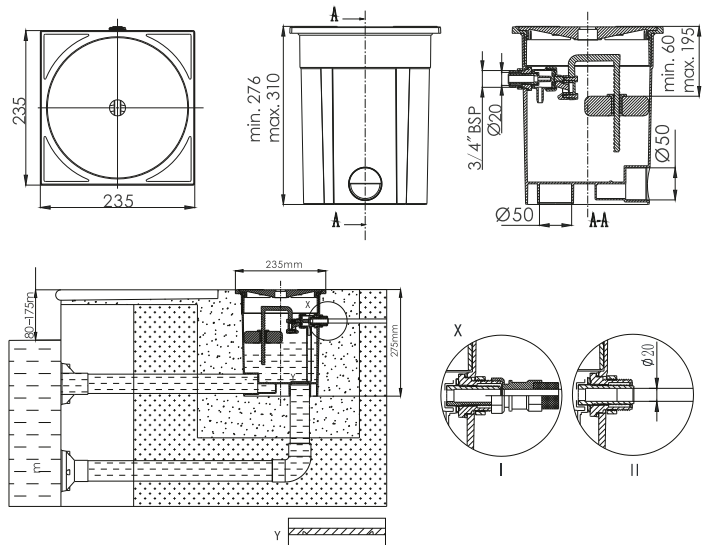

Code	Model	Color	Material	Connection	Flow Rate (L/min)
88570203	RO-7	White	ABS	Inlet: $\phi 20\text{mm}$ or 3/4" BSP, Outlet: $\phi 50\text{mm}$	30 - 50

## Conduit EM2841

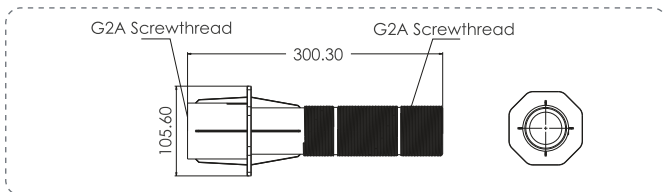

Code	Model	Connection	Application	Flow Rate (L/min)
91602501	EM2841	1.5"/50mm Solvent, G2A Screwthread	Concrete Pool	150-240

## Conduit EM2842

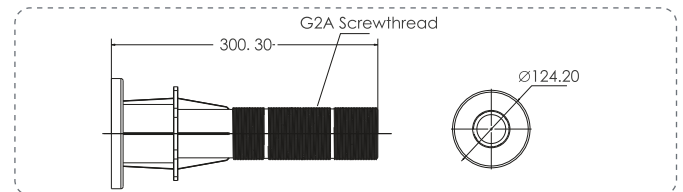

Code	Model	Connection	Application	Flow Rate (L/min)
91602502	EM2842	1.5"/50mm Solvent, G2A Screwthread	Vinyl Pool	150-240

## Vacuum EM2848

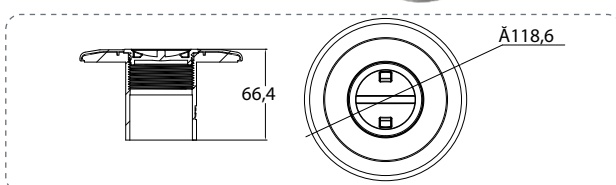

Code	Model	Connection	Measure	Flow Rate (L/min)
91601518	EM2848(A)	1.5" / 2" Class 12 Solvent	Imperial	150-240
91601520	EM2848(A1)	2" Class 15 Solvent	Imperial	150-240
91601519	EM2848(E)	50mm / 63mm PN10 Solvent	Metric	150-240
91601521	EM2848(E1)	63mm PN16 Solvent	Metric	150-240

## Hydrostatic Valve EM2510

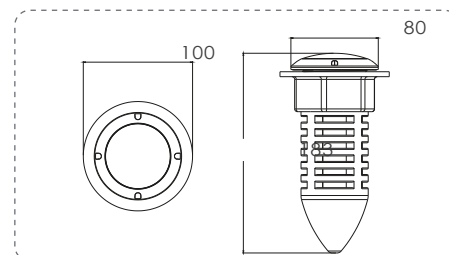

Code	Model	Description	Flow Rate (L/min)
91600401	EM2510	Hydrostatic Valve	150-240

# Inlet Fittings

## RETURN INLET

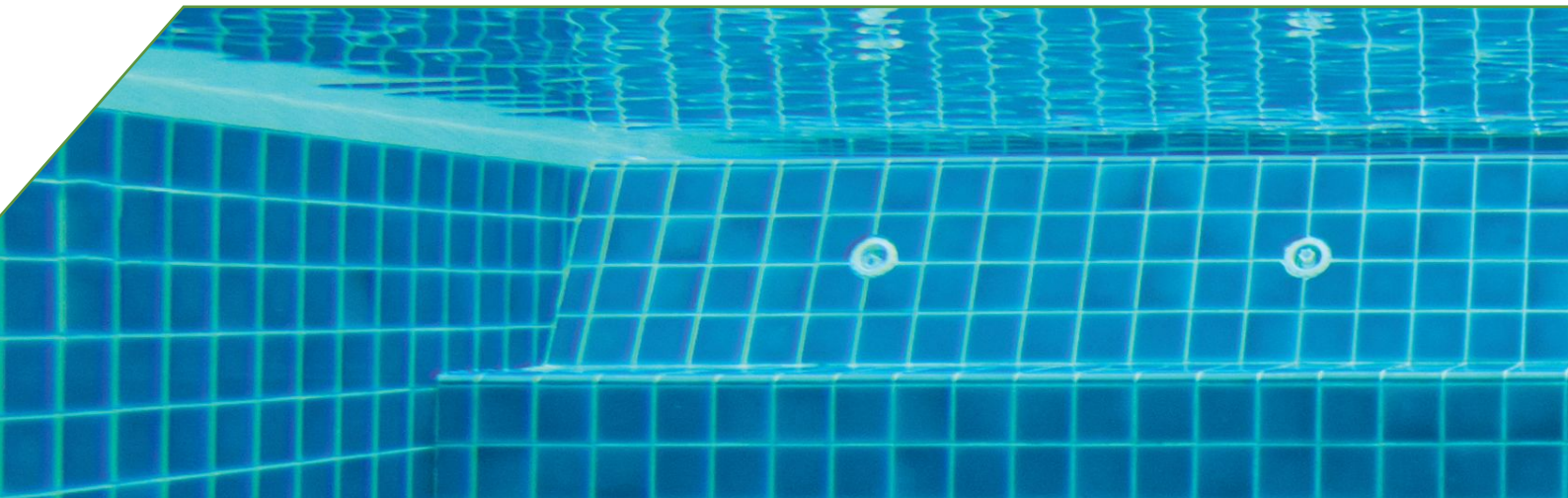

### Return Inlet EM4408



1. For concrete pool
2. Adjustable angle

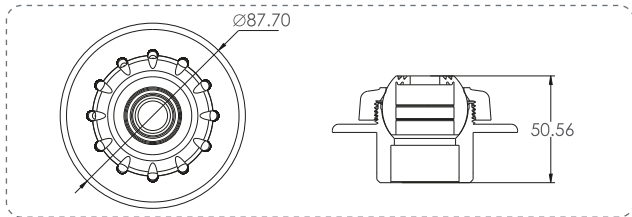

Code	Model	Connection	Flow Rate (L/min)
91601211	EM4408(A)	1 1/2" Class 12 Solvent	50/150
91601234	EM4408(A1)	1 1/2" Class 15 Solvent	50/150
91601212	EM4408(E)	32mm/50mm PN10 Solvent	50/150
91601235	EM4408(E1)	32mm/50mm PN16 Solvent	50/150

### Return Inlet EM4409



1. For concrete pool
2. Adjustable angle

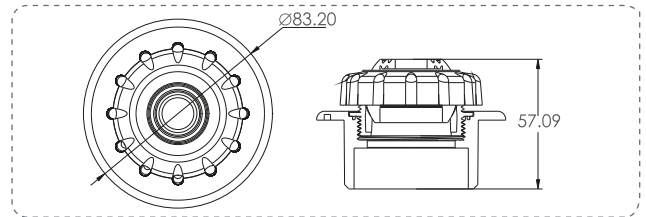

Code	Model	Connection	Flow Rate (L/min)
91601213	EM4409(A)	1.5" / 2" Class 12 Solvent	150/240
91601236	EM4409(A1)	2" Class 15 Solvent	150/240
91601214	EM4409(E)	50mm/63mm PN10 Solvent	150/240
91601237	EM4409(E1)	63mm PN16 Solvent	150/240

### Return Inlet EM4412



1. For vinyl pool
2. Recommended wall conduit EM2842
3. Adjustable angle

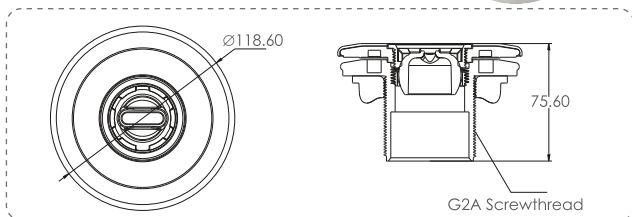

Code	Model	Connection	Brass Inserts	Flow Rate (L/min)
91601219	EM4412(A)	1.5" Solvent, G2A Screwthread	Yes	150
91601220	EM4412(E)	50mm Solvent, G2A Screwthread	Yes	150
91601227	EM4412A TS	1.5" Solvent, G2A Screwthread	No	150
91601228	EM4412E TS	50mm Solvent, G2A Screwthread	No	150

### Return Inlet EM4413



1. For concrete pool
2. Adjustable angle

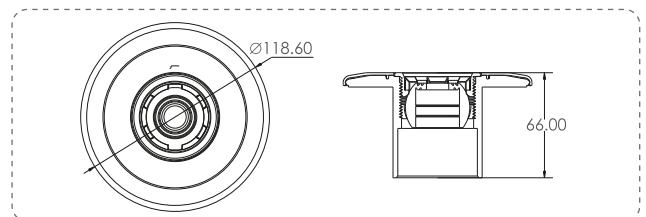

Code	Model	Connection	Flow Rate (L/min)
91601221	EM4413(A)	1.5"/2" Class 12 Solvent	150
91601238	EM4413(A1)	2" Class 15 Solvent	150
91601222	EM4413(E)	50mm/63mm PN10 Solvent	150
91601239	EM4413(E1)	63mm PN16 Solvent	150

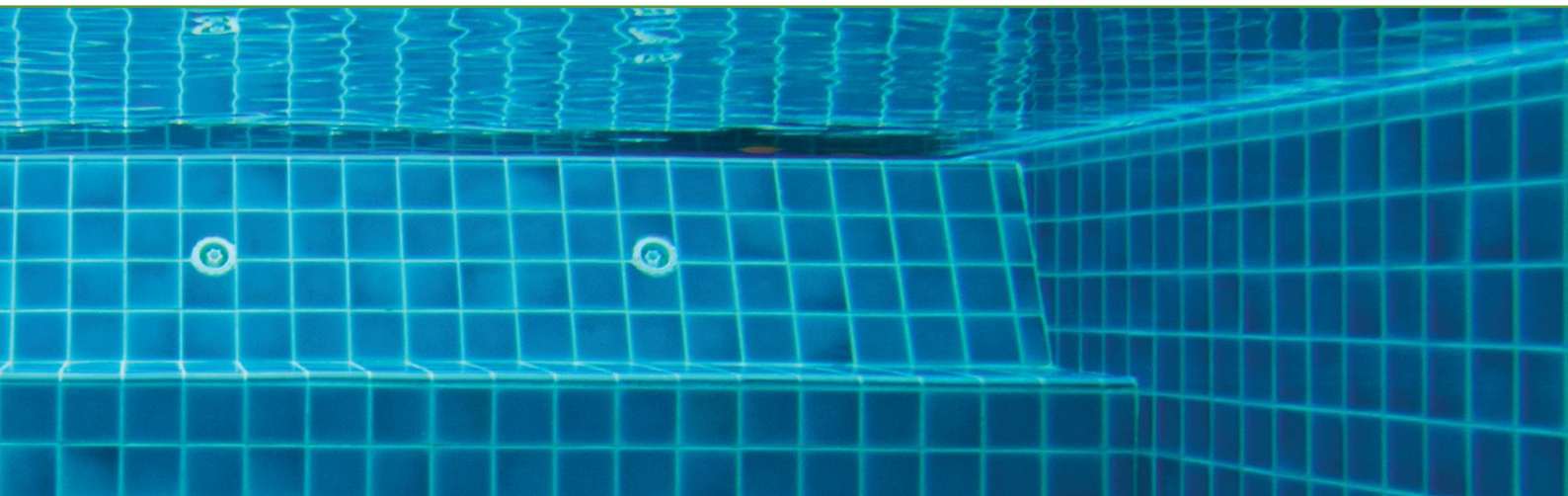

## Return Inlet EM4410

1. For concrete pool
2. Recommended wall conduit EM2841
3. Adjustable angle



## Return Inlet EM4411

1. For concrete pool
2. Recommended wall conduit EM2841
3. Adjustable angle

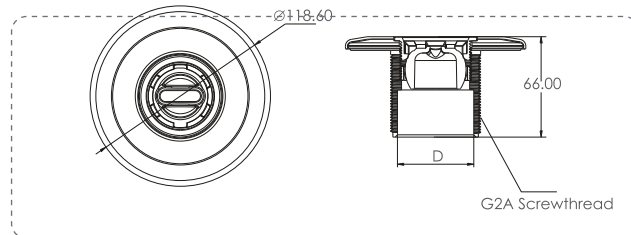
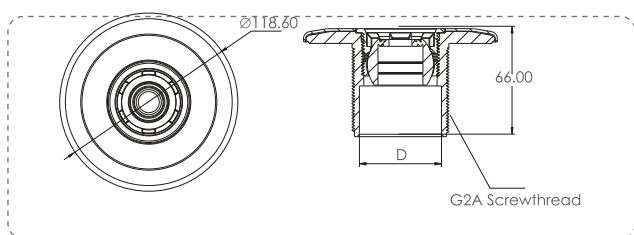

Code	Model	Connection	Flow Rate (L/min)
91601215	EM4410(A)	1.5" Solvent, G2A Screwthread	150
91601216	EM4410(E)	50mm Solvent, G2A Screwthread	150

Code	Model	Connection	Flow Rate (L/min)
91601217	EM4411(A)	1.5" Solvent, G2A Screwthread	150
91601218	EM4411(E)	50mm Solvent, G2A Screwthread	150

## Return Inlet EM4414

1. For vinyl pool
2. Recommended wall conduit EM2842
3. Adjustable angle



## Return Inlet EM4415

1. For vinyl pool
2. Recommended wall conduit EM2842
3. Adjustable angle

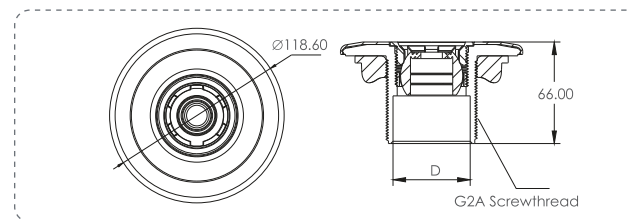
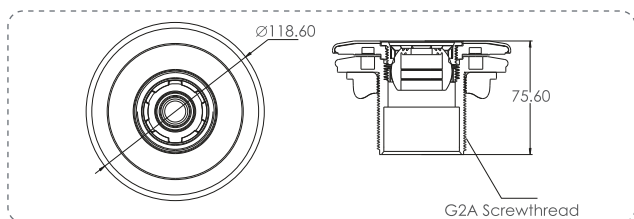

Code	Model	Connection	Brass Inserts	Flow Rate (L/min)
91601223	EM4414(A)	1.5" Solvent, G2A Screwthread	Yes	150
91601224	EM4414(E)	50mm Solvent, G2A Screwthread	Yes	150
91601229	EM4414A TS	1.5" Solvent, G2A Screwthread	No	150
91601230	EM4414E TS	50mm Solvent, G2A Screwthread	No	150

Code	Model	Connection	Flow Rate (L/min)
91601225	EM4415(A)	1.5" Solvent, G2A Screwthread	150
91601226	EM4415(E)	50mm Solvent, G2A Screwthread	150

# Inlet Fittings

WALL RETURN

FLOOR INLET

## Wall Return EM2824

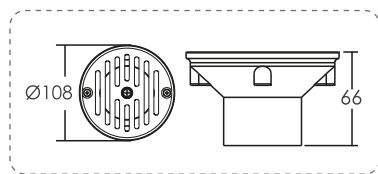

Code	Model	Connection	Measure	Flow Rate (L/min)
91600806	EM2824(A1)	1.25" Solvent	Imperial	92
91600807	EM2824(A2)	1.5" Solvent	Imperial	150
91600808	EM2824(A3)	2" Solvent	Imperial	240
91600809	EM2824(E1)	50mm Solvent	Metric	150
91600810	EM2824(E2)	63mm Solvent	Metric	240

## Wall Return EM2825

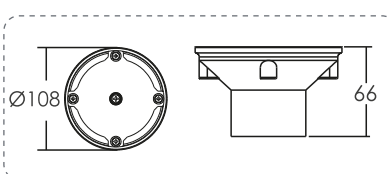

Code	Model	Connection	Measure	Flow Rate (L/min)
91600811	EM2825(A1)	1.25" Solvent	Imperial	92
91600813	EM2825(A2)	1.5" Solvent	Imperial	150
91600812	EM2825(A3)	2" Solvent	Imperial	240
91600814	EM2825(E1)	50mm Solvent	Metric	150
91600815	EM2825(E2)	63mm Solvent	Metric	240

## Wall Return EM2826

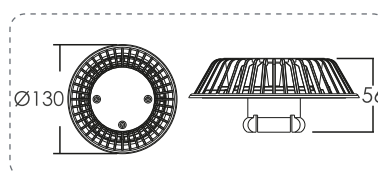

Code	Model	Connection	Measure	Flow Rate (L/min)
91600816	EM2826(A1)	1.5" Solvent	Imperial	122
91600817	EM2826(A2)	2" Solvent	Imperial	200
91600818	EM2826(E1)	50mm Solvent	Metric	150

## Floor Inlet EM2861

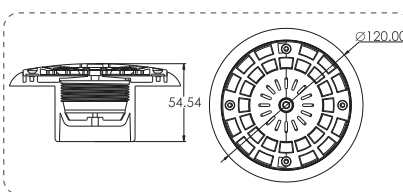

Code	Model	Connection	Application	Flow Rate (L/min)
91600819	EM2861(A)	2" Class 12 Solvent	Concrete Pool	200
91600826	EM2861(A1)	2" Class 15 Solvent	Concrete Pool	200
91600820	EM2861(E)	63mm PN10 Solvent	Concrete Pool	200
91600827	EM2861(E1)	63mm PN16 Solvent	Concrete Pool	200

## Floor Inlet EM2862

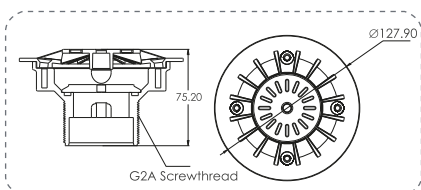

Code	Model	Connection	Application	Flow Rate (L/min)
91600821	EM2862(A)	1.5" Solvent, G2A Screwthread	Concrete Pool	200
91600822	EM2862(E)	GB50 Solvent, G2A Screwthread	Concrete Pool	200

## Floor Inlet EM2817

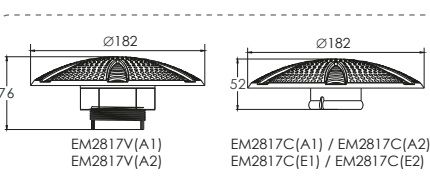

Code	Model	Connection	Application	Flow Rate (L/min)
91600520	EM2817V(A1)	1.5" Class 12 Solvent	Vinyl Pool	328
91600521	EM2817V(A2)	2.0" Class 9 Solvent	Vinyl Pool	328
91600518	EM2817C(A1)	1.5" Class 12 Solvent	Concrete Pool	328
91600519	EM2817C(A2)	2.0" Class 9 Solvent	Concrete Pool	328
91600526	EM2817C(A3)	1.5" Class 15 Solvent	Concrete Pool	328
91600527	EM2817C(A4)	2.0" Class 15 Solvent	Concrete Pool	328
91600530	EM2817C(A5)	1.5" Class 9 Solvent	Concrete Pool	328
91600531	EM2817C(A6)	2.0" Class 12 Solvent	Concrete Pool	328
91600524	EM2817C(E1)	50mm PN10 Solvent	Concrete Pool	328
91600525	EM2817C(E2)	63mm PN10 Solvent	Concrete Pool	328
91600528	EM2817C(E3)	50mm PN16 Solvent	Concrete Pool	328
91600529	EM2817C(E4)	63mm PN16 Solvent	Concrete Pool	328

## Floor Inlet EM2863

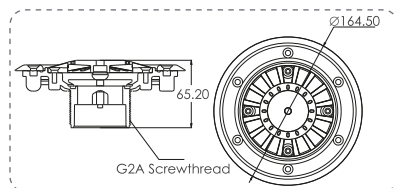

Code	Model	Connection	Application	Flow Rate (L/min)
91600823	EM2863(A)	1.5" Solvent, G2A Screwthread	Vinyl Pool	200
91600824	EM2863(E)	GB50 Solvent, G2A Screwthread	Vinyl Pool	200

# Inlet Fittings

## JET AND JET BODY

### φ10mm Barb Air & φ20mm Barb Water, Ell Body

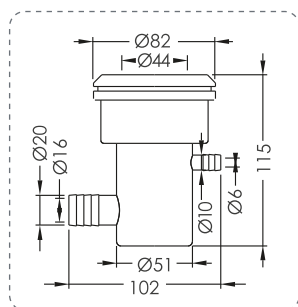

Code	Model	Material	Flow Rate (L/min)
88100112	EM0021	ABS	53

### φ32mm Air & φ50mm Water, Tee Body

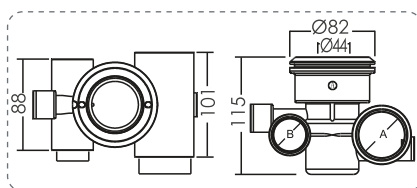

Code	Model	Material	A	B	Flow Rate (L/min)
91601302	EM0031(A)	ABS	1.5"	1"	76
91601303	EM0031(E)	ABS	50mm	32mm	76

### Eyeball Standard Jet

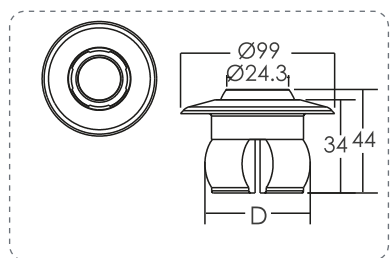

Code	Model	Material	D	Flow Rate (L/min)
91601205	EM3301(A1)	ABS	1.5" Class 12 Solvent	69
91601206	EM3301(A2)	ABS	2" Class 12 Solvent	69
91601207	EM3301(E1)	ABS	50mm PN10 Solvent	69
91601240	EM3301(E2)	ABS	50mm PN16 Solvent	69

### Eyeball Jet

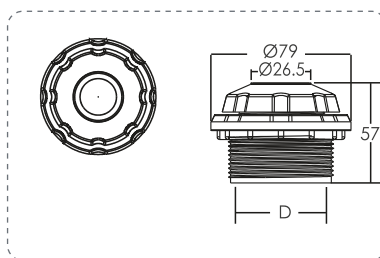

Code	Model	Material	D	Flow Rate (L/min)
91601208	EM3302(A)	ABS	1.5"	69
91601209	EM3302(E)	ABS	50mm	69

### Swirl Jet

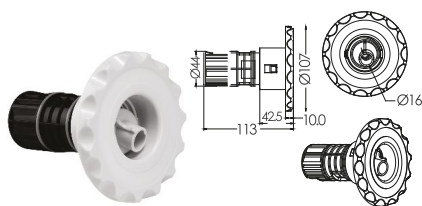

Code	Model	Flow Rate (L/min)
88090712	EM0018	17

### Swirl Jet

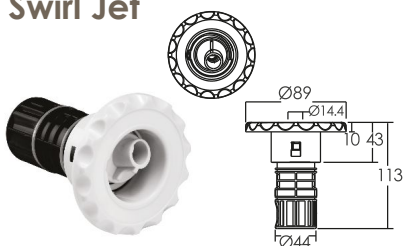

Code	Model	Flow Rate (L/min)
88090512	EM0028	17

### Standard Jet

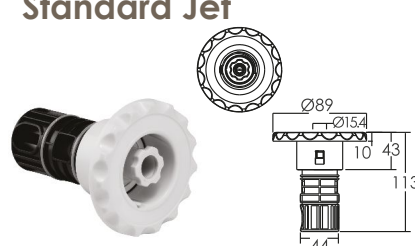

Code	Model	Flow Rate (L/min)
88090412	EM0034	17

### Smooth Face Standard Jet

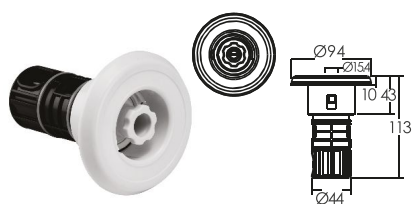

Code	Model	Flow Rate (L/min)
88090812	EM0044	17

### Smooth Face Swirl Jet

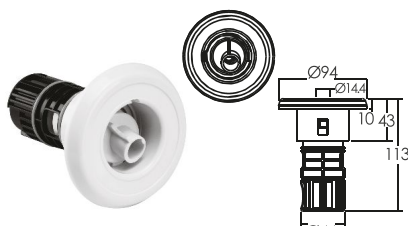

Code	Model	Flow Rate (L/min)
88090912	EM0048	17

### Standard Jet

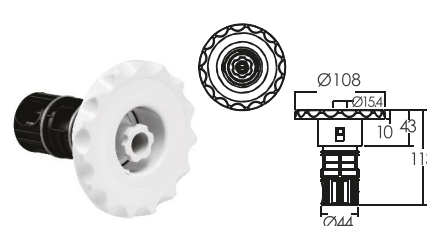

Code	Model	Flow Rate (L/min)
88090612	EM0064	17

# Grating System

ANTI-SLIP, SAFE, DURABLE AND UNIVERSAL



## TPV Antiskid Grating

### Product Features

- Materials : Polypropylene (PP) + Glass Filled
- Anti-slip materials: Thermoplastic Vulcanizate(TPV)
- Durable, UV resistant
- Standard color : White / Blue
- MOQ required for other colors

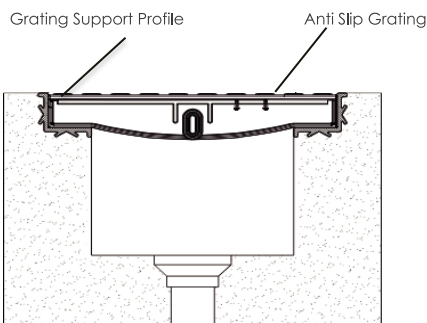
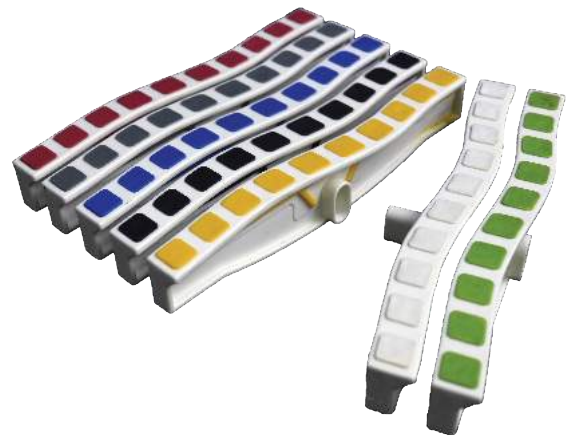

Code	Model	Colour	Size
88171001	DE2720W	White	200 x 26.5 mm (1m)
88171008	DE2720B	Blue	200 x 26.5 mm (1m)
88171101	DE2725W	White	250 x 26.5 mm (1m)
88171108	DE2725B	Blue	250 x 26.5 mm (1m)
88171201	DE2730W	White	300 x 26.5 mm (1m)
88171208	DE2730B	Blue	300 x 26.5 mm (1m)

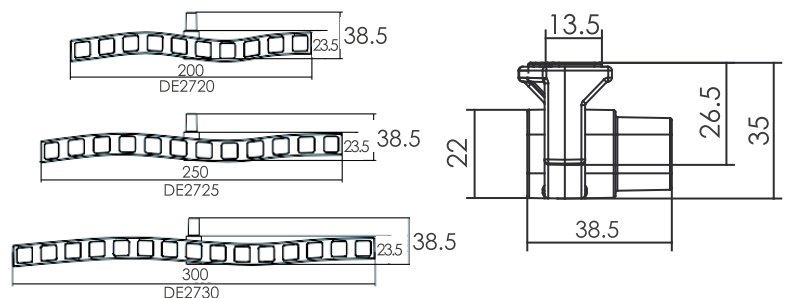

# Grating

## Zigzag Type Grating

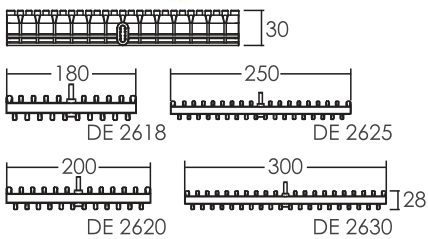

Code	Model	Size
88170612	DE2618	180 x 30 mm (1m)
88170712	DE2620	200 x 30 mm (1m)
88170812	DE2625	250 x 30 mm (1m)
88170912	DE2630	300 x 30 mm (1m)

## Bendable Grating

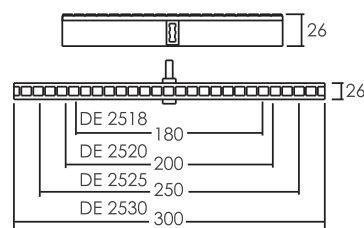

Code	Model	Size
88170212	DE2518	180 x 26 mm (1m)
88170312	DE2520	200 x 26 mm (1m)
88170412	DE2525	250 x 26 mm (1m)
88170512	DE2530	300 x 26 mm (1m)

## Floor Pad

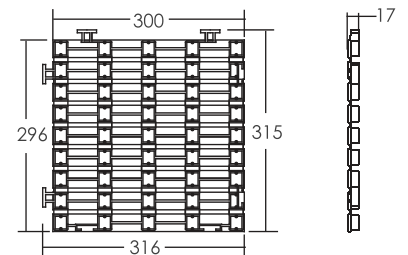

Code	Model	Colour	Size
88160112	DE3030	White	300 x 300 mm
88160106	DE3030	Red	300 x 300 mm
88160107	DE3030	Yellow	300 x 300 mm
88160108	DE3030	Blue	300 x 300 mm
88160109	DE3030	Green	300 x 300 mm

# Corner Tile and Profile

## 90° Fiberglass Corner Tile

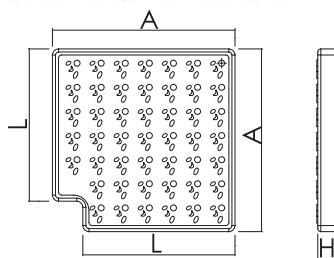

Code	Model	A mm	H mm	L mm
88470101	FT3090	350	28.5	300
88470301	FT2590	300	28.5	250
88470501	FT2090	250	28.5	200

## 45° Fiberglass Corner Tile

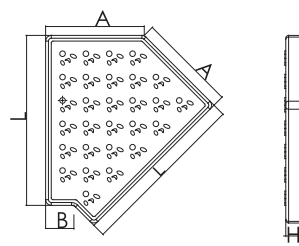

Code	Model	A mm	B mm	H mm	L mm
88470201	FT3045	174	50	28.5	300
88470401	FT2545	154	50	28.5	250
88470601	FT2045	133	50	28.5	200

## Grating Support Profile

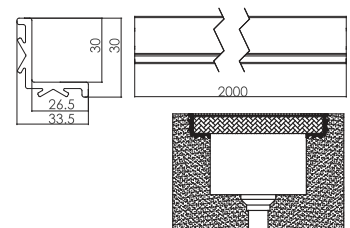

Code	Description
01150047	Support Profile

# Spa Jet and Fittings

## OPTIMISED SPA EXPERIENCE



L-Type Jet Body

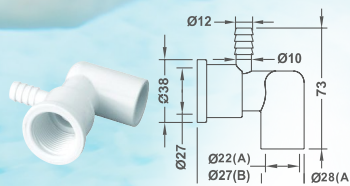

Code	Model No.	Material
88100812	EM2201A	PVC
88100912	EM2201B	PVC

L-Type Jet Body

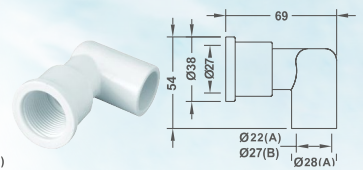

Code	Model No.	Material
88101012	EM2202A	PVC
88101112	EM2202B	PVC

L-Type Jet Body

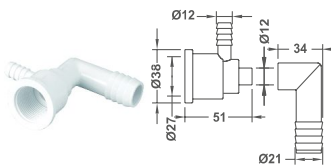

Code	Model No.	Material
88101212	EM2203	PVC

L-Type Jet Body

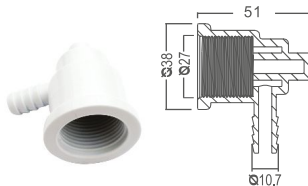

Code	Model No.	Material
88101312	EM2204	PVC

Single Hole Air Jet

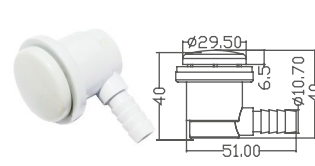

Code	Model No.	Material
88100612	EM1159	PVC

Twin Hole Air Jet

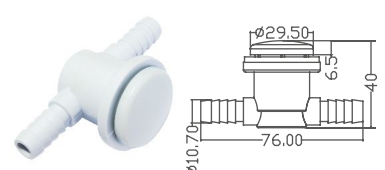

Code	Model No.	Material
88100712	EM1160	PVC

Tiny Air Jet

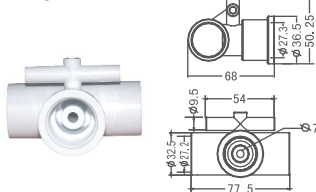

Code	Model No.	Material
88100512	EM1158	PVC

I Type Jet

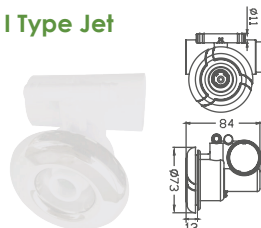

Code	Model No.	Material
88091212	EM1144	ABS&PVC

φ2" Face (Standard) Jet

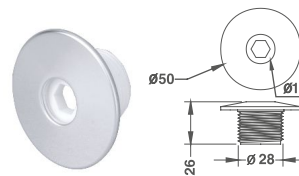

Code	Model No.	Material
88091512	EM2207	ABS

φ1-1/2" Face (Standard) Jet

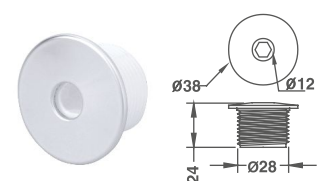

Code	Model No.	Material
88091612	EM2208	ABS

φ1-1/2" Face (Radial) Jet



Code	Model No.	Material
88091712	EM2209	PVC

φ2" Face (Spiral) Jet

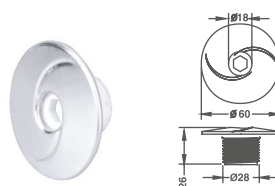

Code	Model No.	Material
88091812	EM2210	PVC

Nine Hole Jet



Code	Model No.	Material
88091912	EM2211	ABS

Single Hole Jet

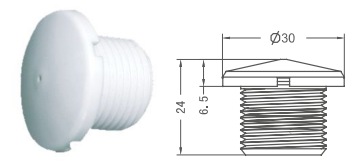

Code	Model No.	Material
88092012	EM2212	ABS&PVC



**φ2-3/4" Vortex Face  
Eyeball Spa Jet**

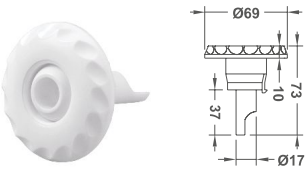

Code	Model No.	Material
88091112	EM1123	PVC

**φ25mm Barb Air & φ25mm  
Water Tee Body**

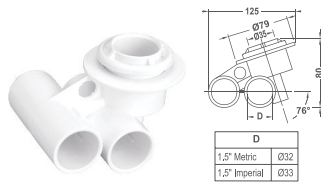

Code	Model No.	Material
88100312	EM1138	PVC

**φ2-3/4" Face  
Eyeball Spa Jet**

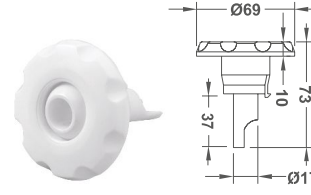

Code	Model No.	Material
88101312	EM1113	PVC

**φ10mm Barb Air &  
φ25mm Water**

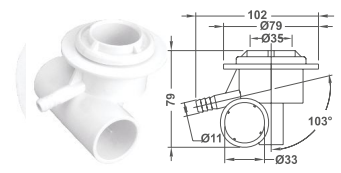

Code	Model No.	Material
88100412	EM1148	PVC

**φ25mm Air Control**

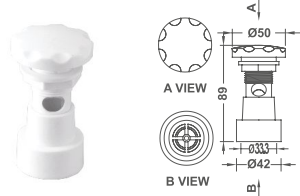

Code	Model No.	Material
88210112	EM1834	ABS

**Standard Air Control**

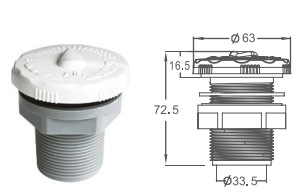

Code	Model No.	Material
88210212	EM1835	ABS

**Air Button**

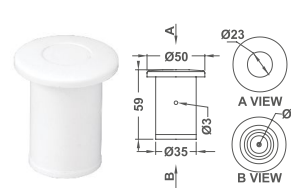

Code	Model No.	Material
88200112	EM1844	ABS

**Air Button**

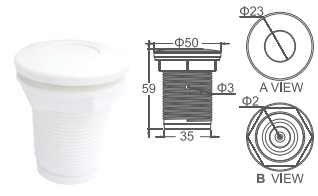

Code	Model No.	Material
88200212	EM1845	ABS

**φ2 Section Drain  
Ell Body(Threaded)**

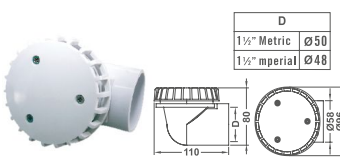

Code	Model No.	Material
88240212	EM3822A	ABS&PVC

**φ2 Section Drain  
Ell Body(Slip Fit)**

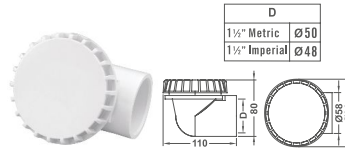

Code	Model No.	Material
88240312	EM3822B	ABS&PVC

**φ2 Section Drain Straight  
Body(with Bolt)**

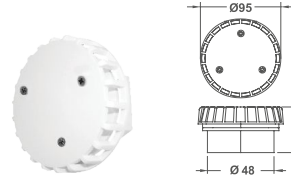

Code	Model No.	Material
88240412	EM3833A	ABS&PVC

**φ2 Section Drain  
Straight Body**

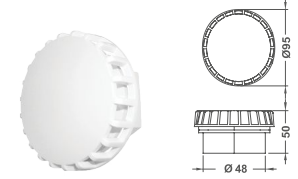

Code	Model No.	Material
88240512	EM3833B	ABS&PVC

**Swirl Type  
Water Return**

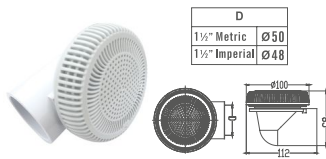

Code	Model No.	Material
88240612	EM3844	ABS&PVC

**Water Return**



Code	Model No.	Material
88240812	EM3845	ABS&PVC

**φ2 Section Drain  
Lock Nut**

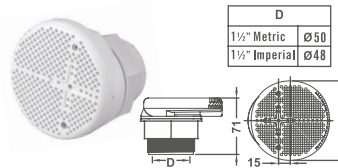

Code	Model No.	Material
88240112	EM3811	ABS&PVC
88240102	EM3811	ABS&PVC

**Port Air  
Manifold**

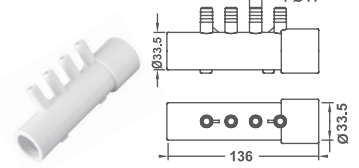

Code	Model No.	Material
88180212	EM1825	ABS

**Port Water Barb  
Manifold**

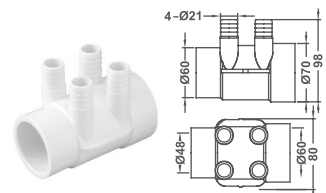

Code	Model No.	Material
88180112	EM1824	ABS

**Barb Plug**

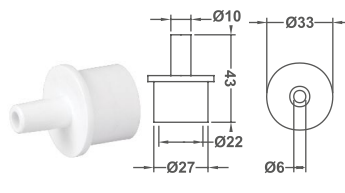

Code	Model No.	Material
88190212	EM1816	PVC

**Pipe Plug**

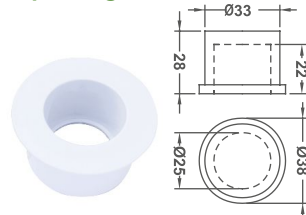

Code	Model No.	Material
88190512	EM1818B	PVC

**Pipe Plug**

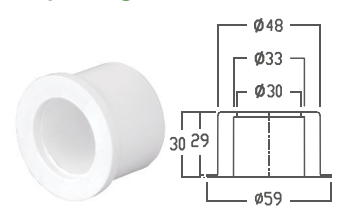

Code	Model No.	Material
88190312	EM1818A	PVC





**EMAUX WATER TECHNOLOGY CO., LTD**  
ADDRESS G/F 41 TIN HAU TEMPLE ROAD,  
NORTH POINT, HONG KONG  
PHONE +852 2832 9880  
[www.emauxgroup.com](http://www.emauxgroup.com)

 **STRIVE FOR CLEAR WATER**

Available from: